

Air Brake Manual

Training & Reference Guide

2007



For vehicles with air brake systems

A supplement to the Basic Licence Driver's Handbook

Table of Contents

CHAPTER 1

Brakes and Braking

Heat-energy-traction-friction	6
Speed-weight-distance	8
Braking force	9
Stopping distance	12

CHAPTER 2

Components of an Air Brake System

The components of an air brake system	16
Compressor and governor	16
Reservoirs	20
Safety valve	22
Air dryer	22
Foot valve	23
Brake chambers, slack adjusters and brake linings	24
Foundation brakes	30
Wedge brakes	31
Disc brakes	32
Air-over-hydraulic brake system	33
Air actuated hydraulic brake system	34
Air-boost hydraulic brake system	35

CHAPTER 3

How the Basic System Works

Basic air brake system	40
One-way check valve	41

Air pressure gauge	41
Brake application gauge	42
Low pressure warning device	43
Stop light switch	43
Quick release valve	43
Relay valve	44
Manual front brake limiting valve	45
Automatic front brake limiting valve	46
Tandem rear axles	47

CHAPTER 4

Spring Parking Brakes

Single Circuit System

Spring parking brake systems	50
Using a spring parking brake	50
Dual control valve and reservoir	55
Mechanical release (caging brake)	56

CHAPTER 5

Trailer System

Single Circuit System

Glad hands	61
Application line	63
Trailer brake hand valve	65
Two-way check valve	66
Tractor protection system	70
Tractor protection valve	71
Trailer supply valve	74
Automatic trailer supply valve system	74
Tractor and trailer coupled	78
Charging the trailer system	80
Foot or hand valve brake application	82

Emergency application	85
Supply (emergency) line rupture	86
Control (service) line rupture	88
Loss of reservoir air pressure	90
Manual trailer supply valve	93
Trailer spring parking brakes	94

CHAPTER 6

Dual Air Brake System

Dual air brake system with spring parking brakes	101
Spring parking brakes with modulator valve	102
Combination tractor and trailer with spring parking brakes	103

CHAPTER 7

Brake Adjustment and In-Service Check

Brake adjustment	108
S-cam brake	108
Stroke vs. force	110
S-cam brake adjustment with manual slack adjuster	111
S-cam brake with automatic slack adjuster	114
Disc brake adjustment	114
Wedge brake adjustment	114
After a brake adjustment	115
In-service checks	116

Maintenance and servicing of the air brake system	117
--	-----

CHAPTER 8

Pre-Trip Air Brake Inspection

Single unit	120
Combination unit	124
Air-over-hydraulic (air actuated) brake system	129

CHAPTER 9

Electronic Controlled Braking and Traction System

Anti-lock brake system (ABS)	136
Automatic traction control (ATC)	136

Introduction

A message from Road Licensing and Safety

Most large commercial vehicles are equipped with an air brake system. You must have an air brake endorsement on your driver's licence to drive these vehicles.

The purpose of this handbook is to introduce you to the knowledge and skills you need to drive a vehicle with air brakes in a safe and lawful manner. It contains the information you need to prepare for the Road Licensing and Safety Division air brake endorsement examination.

As you read this handbook, remember it is only a guide. It contains basic information about common air brake systems. Each vehicle and its air brake system may have features and components that are different from those described in this handbook. As a driver, it is your responsibility to become familiar with all the characteristics of a vehicle before you drive it.

REMEMBER: You rarely run out of brakes, but you run out of adjustment. (The brake components could all be new but if the adjustment is not done, the brakes will not do their job.)

Drive to live.

Government of the Northwest Territories

Department of Transportation, Road Licensing and Safety

Website: www.dot.gov.nt.ca

Road Licensing and Safety Division recommends that all drivers wishing to upgrade seek professional training from a licensed training school.

If you require further information regarding driver training schools or the driver examination process, please contact Road Licensing and Safety Headquarters:

Yellowknife (867) 873-7406.

All handbooks, knowledge, testing and licensing services are available from any Issuing Agent office. Practical skill and road tests are available through certified driver examiners. Please refer to your local telephone Blue Pages under Motor Vehicles or check out the web site at: www.gov.nt.ca/transportation to locate these services.

This handbook is a guide only and has no legal authority. The laws that apply to operating a vehicle with an air brake system can be found in the Motor Vehicles Act and its related Regulation(s). This information is available from:

Canarctic Graphics
5102-50th Street
P.O. Box 2758
Yellowknife NT X1A 2R1
Telephone: (867) 873-5924
Fax: (867) 920-4371

or

Website: www.justice.gov.nt.ca/Legislation/SearchLeg&Reg.htm



The Department of Transportation, Road Licensing and Safety Division, would like to express its appreciation to Kingland Freightliner of Hay River, Northwest Territories for their role in the development of this manual by providing the air brake components that have been digitally reproduced. Please note that Kingland Freightliner will not be held responsible for the content of this handbook.

This handbook is a guide only and should not be used to interpret a point of law. Official statutes should be consulted for that purpose.

1

Chapter 1

NWT Air Brake Manual

BRAKES AND BRAKING

1

Brakes and Braking

Heat-Energy-Traction-Friction

For a vehicle to move along the highway, an internal combustion engine must convert its heat energy into mechanical energy. This mechanical energy goes from the engine to the driving wheel tires by means of a system of connecting rods, shafts and gears. The final factor that moves the vehicle is the amount of traction its tires have on the road surface.

Friction is the force that resists movement between two surfaces in contact with each other. To stop a vehicle, the brake shoe linings are forced against the machined surfaces of the brake drums, creating friction. This friction produces heat.

The engine converts the energy of heat into the energy of motion; the brakes must convert this energy of motion back into the energy of heat. The friction between brake drums and linings generates heat while reducing the mechanical energy of the revolving brake drums and wheels. The heat produced is absorbed by the metal brake drums, which dissipate the heat into the atmosphere. The amount of heat the brake drums can absorb depends on the thickness of the metal. When enough friction is created between the brake lining and the drums, the wheels stop turning. The final factor that stops the vehicle is the traction between the tires and the road surface.

If a 200-horsepower engine accelerates a vehicle to 100 km/h in one minute, imagine the power needed to stop this same vehicle. Also, consider that the vehicle might have to stop in an

emergency in as little as six seconds (just 1/10 the time it took to reach 100 km/h).

To stop the vehicle in 1/10 the time it took to accelerate would require a stopping force of 10 times the acceleration force -- the equivalent of approximately 2,000 horsepower. If the vehicle had six wheels, each wheel would have to provide 1/6 the braking force. If one or two of the wheels had brakes that were not properly adjusted, the other wheels would have to do more than their share of the braking, and that might be more than their brakes were constructed to stand. Excessive use of the brakes would then result in a buildup of heat greater than the brake drums could absorb and dissipate. Brake drums are constructed of metal, therefore as they heat up, they expand away from the brake linings. Too much heat can result in brake fade, brake damage and/or brake failure. Brake fade is a result of when your brakes stop operating properly because they have become overheated. This heat that is created can actually cause the brake components or tires to catch fire.

Brake Drums

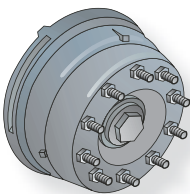

250°C
Normal

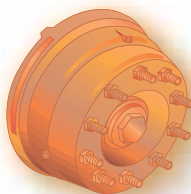

425°C
Maximum



1100°C
Panic!

Most brake linings operate best at around 250°C and should

1

not exceed 425°C. It's important to understand that the power needed to stop generates heat which could damage the brakes.

Speed-Weight-Distance

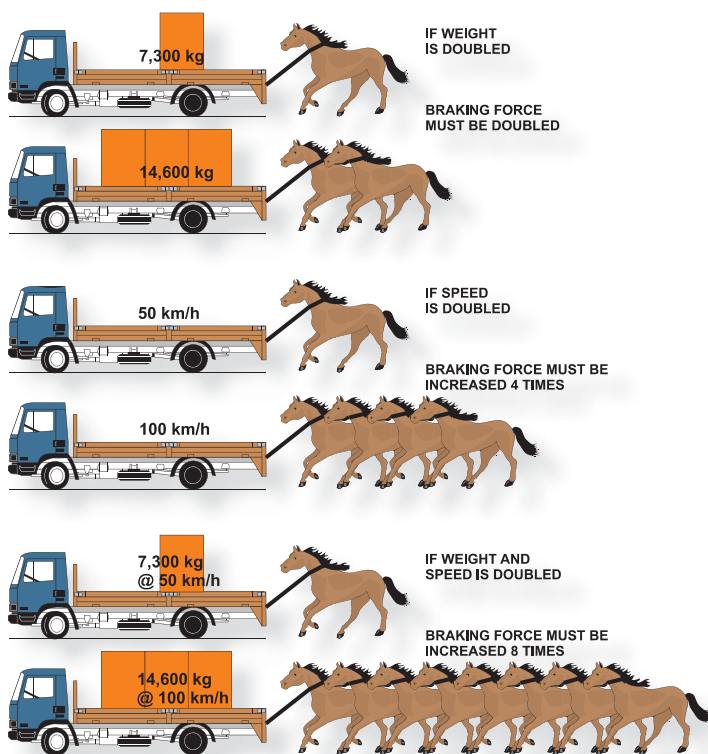

The distance required to stop a vehicle depends on its speed and weight, in addition to energy, heat and friction. The braking force required to stop a vehicle varies directly with its weight and speed. For example, if the weight is doubled, the braking force must be doubled to be able to stop in the same distance.

If the speed is doubled, the braking force must be increased four times to be able to stop in the same distance.

When weight and speed are both doubled, the braking force must be increased eight times to be able to stop in the same distance. For example, a vehicle carrying a load of 7,300 kg at 50 km/h is brought to a stop in 150 metres with normal application of the brakes. If this same vehicle carried 14,600 kg at 100 km/h, it would require eight times the braking force to stop the vehicle in 150 metres. This would be more braking force than the brakes could provide. No vehicle has enough braking force when it exceeds its limitations.

Braking Force

Mechanical

Braking systems use devices to gain a mechanical advantage. The most common device for this purpose is leverage. Look at this simple lever system:

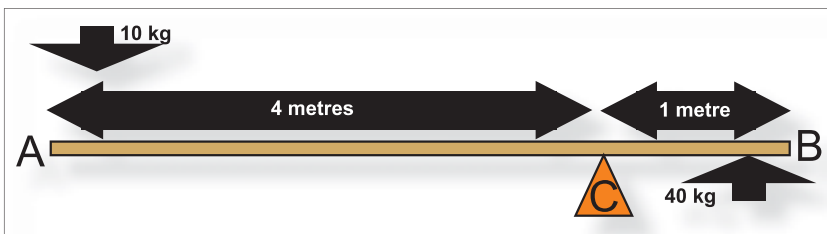

A lever is placed on a pivot called the fulcrum. As the distance from A to C is four metres, and from C to B is one metre, the ratio is four to one (4:1). Force has been multiplied by the leverage principle. If a 10 kg downward force is applied at point A, then the upward force at point B is 40 kg.

1

Use of Air Pressure

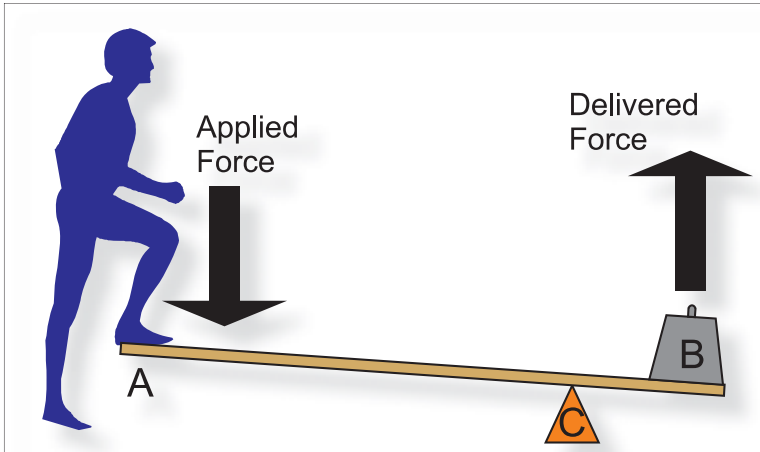

Force can also be multiplied by the use of air to gain further mechanical advantage. Everyone has felt the force of air on a windy day. Air can be compressed (squeezed) into a much smaller space than it normally would occupy, for instance, air compressed in tires to support the weight of a vehicle. The smaller the space into which air is squeezed, the greater the air's resistance to being squeezed. This resistance creates pressure, which is used to gain mechanical advantage.

If a constant supply of compressed air is directed through a pipe that is one inch square, and if a one inch square plug were placed in the pipe, the compressed air would push against the plug. A scale can be used to measure how many pounds of force are being exerted by the air against the plug.

If the scale registers 10 pounds, for example, then it could be said the force is 10 pounds on the one square inch surface of the plug or 10 pounds per square inch (psi).

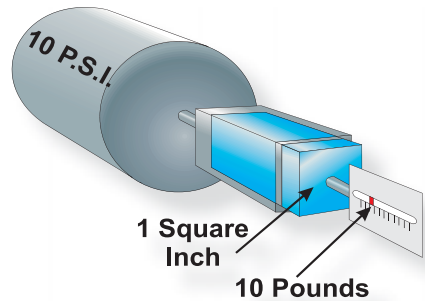

The more compressed the air in the supply reservoir, the greater the force exerted on the face of the plug.

Leverage and Air Pressure

In actual operation, pipes are round and plugs are diaphragms of flexible material acting against push rods. If compressed air of 120 psi acts on a diaphragm of 30 square inches, 3,600 lb of force is produced (120×30). Apply this force to a push rod to move a 6-inch slack adjuster operating a cam and the total force equals 21,600 inch pounds torque ($3,600 \times 6$), or 1,800 foot pounds torque ($21,600 \div 12$). It requires 25 to 30 foot pounds of torque to tighten the wheel on a car. This comparison illustrates the force obtained from using mechanical leverage and air pressure combined.

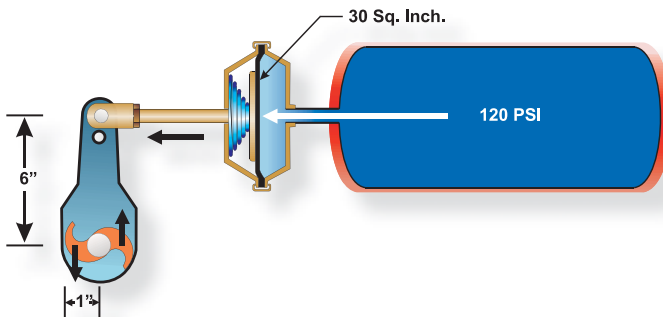

1

Stopping Distance

Stopping distance consists of three factors:

- Driver's reaction time
- Brake lag
- Braking distance

Driver's reaction time: Reaction time is often called "thinking time." The time it takes from the moment a hazard is recognized to the time the brake is applied, approximately $\frac{3}{4}$ of a second.

Brake lag: As air is highly compressible, it requires a relatively large volume of air to be transmitted from the reservoir to the brake chamber before there is enough pressure for the brakes to apply. It can be said that brake lag is the time it takes the air to travel through a properly maintained air brake system (approximately $\frac{4}{10}$ of a second).

Braking distance: The actual distance the vehicle travels after the brake is applied until the vehicle stops. The distance depends on the ability of the brake lining to produce friction, the brake drums to dissipate heat and the tires to grip the road. Drivers should never take their brakes for granted. The braking system must be tested and the adjustment checked before placing the vehicle into service. Drivers must understand the braking system, realize its capabilities and limitations, and learn to use them to the best advantage. Heavy vehicles require powerful braking systems that are obtained by use of mechanical leverage and air pressure. Brakes must be used keeping in mind the heat generated by friction. If the heat becomes too great, braking effectiveness will be lost. The

heavier the load and the faster the speed, the greater the force needed to stop. It is important to remember that an air brake equipped vehicle, even with properly adjusted brakes, will not stop as quickly as a passenger car.

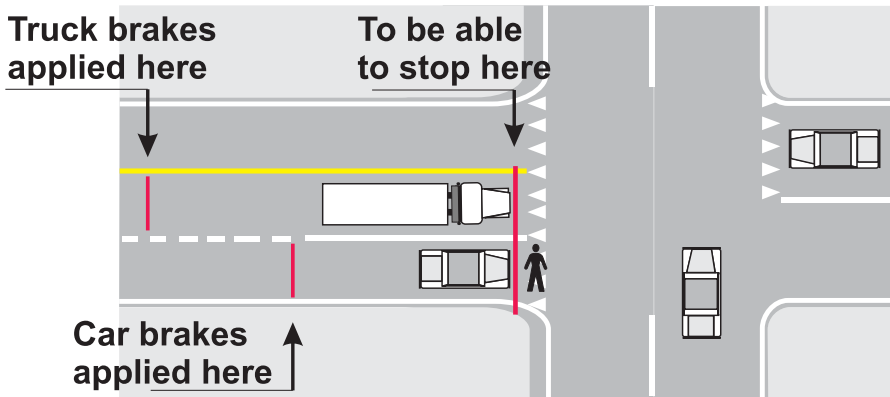



Chapter 2

NWT Air Brake Manual

COMPONENTS OF AN
AIR BRAKE SYSTEM

2

The Components of an Air Brake System

Chapter One of this manual explained that with the use of leverage a mechanical advantage can be gained. Next we learned that air under pressure, when added to the mechanical advantage of the lever, increased the output force. Chapter Two will explain how air under pressure can be used to operate the air brakes of a vehicle.

A basic air brake system capable of stopping a vehicle has five main components:

- A **compressor** to pump air with a **governor** to control it.
- A **reservoir** or tank to store the compressed air.
- A **foot valve** to regulate the flow of compressed air from the reservoir when it is needed for braking.
- **Brake chambers** and **slack adjusters** to transfer the force exerted by the compressed air to mechanical linkages.
- **Brake linings** and **drums or rotors** to create the friction required to stop the wheels.

It is necessary to understand how each of these components work before studying their functions in the air brake system.

Compressor and Governor

Compressed air is used to transmit force in an air brake system. The source of the compressed air is a compressor. A compressor is designed to pump air into a reservoir which results in pressurized air.

The compressor is driven by the vehicle's engine. Most compressors today are driven by shafts and gears, others were driven by belts and pulleys. Belt driven compressors require regular daily checks for belt cracks and tension. Also, check the compressor for broken mounting brackets or loose bolts.

The compressor is in constant drive with the engine. Whenever the engine is running, so is the compressor. When pressure in the system is adequate, anywhere from a low of 80 psi to a high of 135 psi, it is not necessary for the compressor to pump air. A governor controls the minimum and maximum air pressure in the system by controlling when the compressor pumps air. This is known as the "loading" or "unloading" stage.

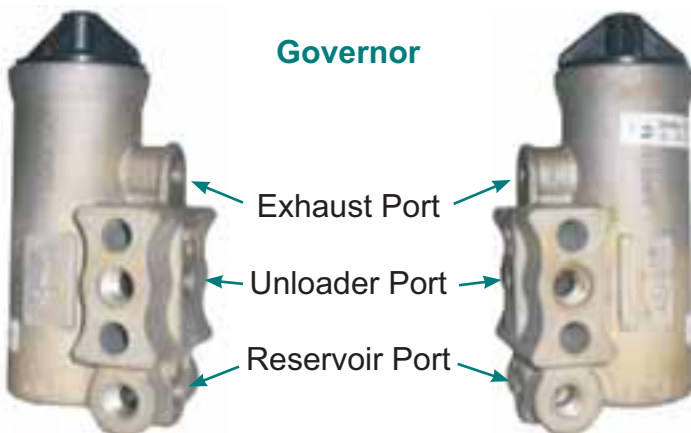

Most compressors have two cylinders similar to an engine's cylinders. When the system pressure reaches its maximum, which is between 105 and 135 psi, the governor places the compressor in the "unloading" stage.

2

The compressor must be able to build reservoir air pressure from 50 to 90 psi within three minutes or less with the engine running at 1,200 RPM. If unable to do so the compressor requires servicing. A compressor may not be able to build air pressure from 50 to 90 psi within three minutes if the air filter is plugged or if the belt is slipping. If these were not at fault the compressor could be faulty.

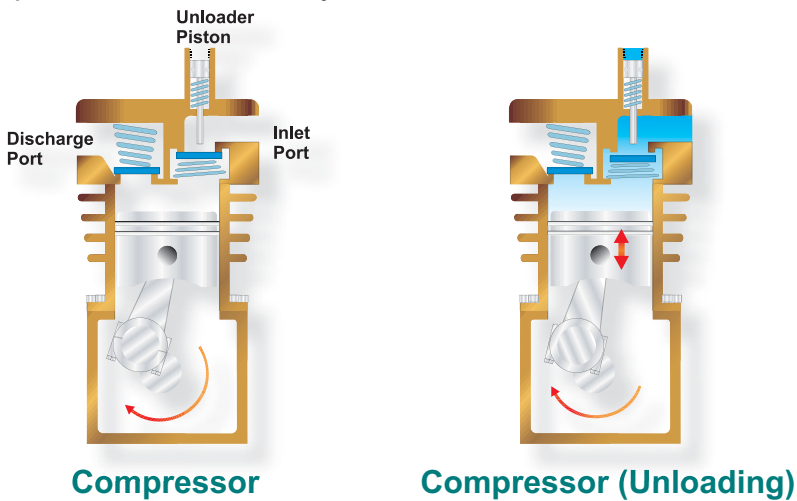

Placing the compressor in the unloading stage is done by directing air pressure to the inlet valves of the compressor, holding them open, allowing the air to be pumped back and forth between the two cylinders, instead of compressing the air. When the pressure in the system drops, the inlet valves close, returning the compressor to the “loading” stage. The governor must place the compressor in the “loading” stage at no lower than 80 psi or approximately 20 psi below maximum system pressure. During the “unloading” stage, the compressor is able to cool.

Usually compressors are lubricated from the engine lubrication system, although some compressors are self-lubricating and require regular daily checks of the lubricant level.

It is very important the air that enters the system be kept as clean as possible. The air must first pass through a filter to remove any dust particles. The air filter must be cleaned regularly. A dirty filter will restrict the flow of air into the compressor, reducing its efficiency. Some vehicles have the inlet port of the compressor connected to the intake manifold and receive air that has been filtered by the engine air cleaner.

A piston type compressor operates on the same principle as the intake and compression strokes of an engine.

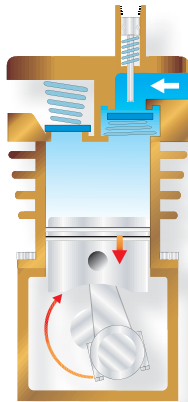

**Compressor
Intake Stroke**

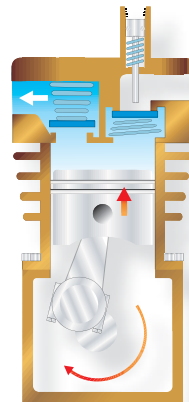

**Compressor
Compression Stroke**

Intake stroke: The downward stroke of the piston creates a vacuum within the cylinder which causes the inlet valve to open.

2

This causes atmospheric air to flow past the inlet valve into the cylinder.

Compression stroke: The upward motion of the piston compresses the air in the cylinder. The rising pressure cannot escape past the inlet valve (which the compressed air has closed). As the piston nears the top of the stroke, the pressurized air is forced past the discharge valve and into the discharge line leading to the reservoir.

Reservoirs

Reservoirs or tanks hold a supply of compressed air. The number and size of the reservoirs on a vehicle will depend on the number of brake chambers and their size, along with the parking brake configuration. Most vehicles are equipped with more than one reservoir. This gives the system a larger volume of main reservoir air. The first reservoir after the compressor is referred to as the supply or wet reservoir. The other reservoirs are known as primary and secondary or dry reservoirs. When air is compressed, it becomes hot. The heated air cools in the reservoir, forming condensation. It is in this reservoir that most of the water is condensed from the incoming air. If oil leaks past the piston rings of the compressor and mixes with this moisture, it forms sludge, which accumulates in the bottom of the reservoir. If allowed to accumulate, this sludge (water and oil) would enter the braking system and could cause trouble with valves and other parts. In winter, water in the system may freeze, causing the malfunction of valves or brake chambers. Reservoirs are equipped with drain valves so that any moisture or sludge that may have accumulated can be drained. If you notice sludge when draining your system, have it inspected

by a mechanic. To minimize the amount of water collection, all reservoirs must be drained daily. Under extreme conditions, reservoirs may have to be drained more than once a day. To drain the reservoirs always start with the supply reservoir on the tractor. Open the drain completely and allow all air pressure to escape, which will then permit the moisture collected in the reservoir to drain.

Reservoir

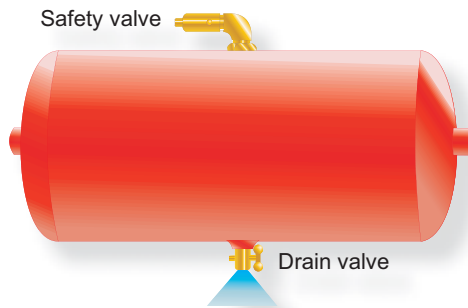

Some reservoirs have more than one compartment and each compartment has its own drain valve, which must be drained individually. Briefly opening the valve just to allow some of the air to escape does not drain the moisture! It is not safe to assume that the supply reservoir, or the presence of an air dryer is reason to neglect the other reservoirs on the power unit, trailers or dollies. They should all be completely drained daily.

Some reservoirs may be equipped with automatic reservoir drain valves (spitter valves). These valves will automatically exhaust moisture from the reservoir when required, although they should be checked daily and drained periodically to ensure the mechanism is functioning properly. Any loose or

2

disconnected wires associated with the valve heaters should be repaired immediately.

Safety Valve

If the governor fails to cut-out the compressor, the safety valve will prevent excessive air pressure to build-up in the system. This valve is located on the supply reservoir and vents air to the atmosphere if the pressure in the reservoir exceeds 150 psi.

Safety Valve

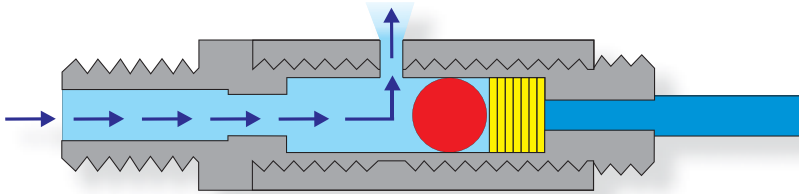

Air Dryer

Air dryers remove moisture and contamination from the air before the air enters the supply reservoirs. The contamination gathered by the dryer is expelled into the atmosphere using air pressure when the governor cuts out the compressor. This expelling of air is often referred to as the air dryer purge cycle. It may be partially filled with a high moisture-absorbent desiccant and an oil filter, or it may be hollow with baffles designed to assist in separating the moisture from the air. The purge valve has a heater element, which prevents the moisture from freezing in cold climate operation. The wiring connected to the heater should be inspected for loose or disconnected wires. They are also equipped with a safety valve.

Air Dryer

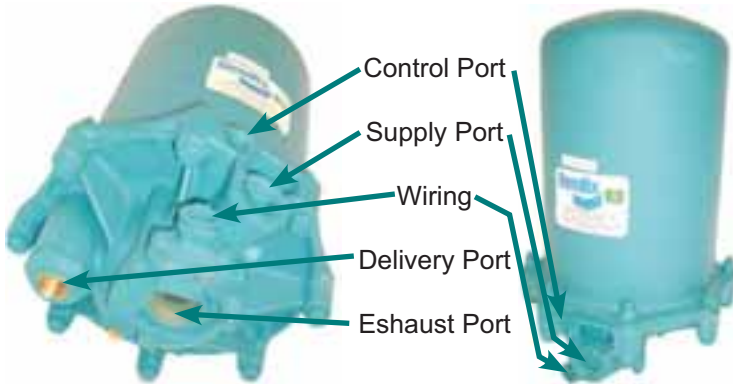

Foot Valve

The foot-operated valve is the means of applying air to operate the brakes. The distance the treadle of the foot valve is depressed by the driver determines the air pressure that will be applied, but the maximum application will not exceed the pressure in the reservoir. Releasing the foot valve treadle releases the brakes.

When the driver applies the brakes, depressing the treadle part way, the foot valve will automatically maintain the application air pressure without the driver having to adjust the pressure of his foot on the treadle.

Releasing the treadle allows the application air to be released through the exhaust ports into the atmosphere. Air treadles are spring loaded, producing a different “feel” from hydraulic brake applications.

2

Foot Valve



Brake Chamber, Slack Adjuster and Brake Lining

Brake Chamber and Slack Adjuster (Brakes released)

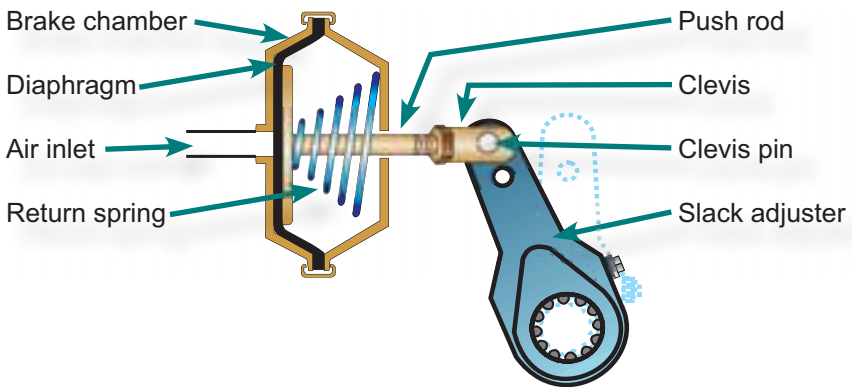

A brake chamber is a circular container divided in the middle by a flexible diaphragm. Air pressure pushing against the

diaphragm causes it to move away from the pressure, forcing the push rod outward against the slack adjuster. The force exerted by this motion depends on air pressure and diaphragm size. If a leak occurs in the diaphragm, air is allowed to escape, reducing the effectiveness of the brake chamber. If the diaphragm is completely ruptured, brakes become ineffective.

Brake Chamber and Slack Adjuster (Brakes applied)

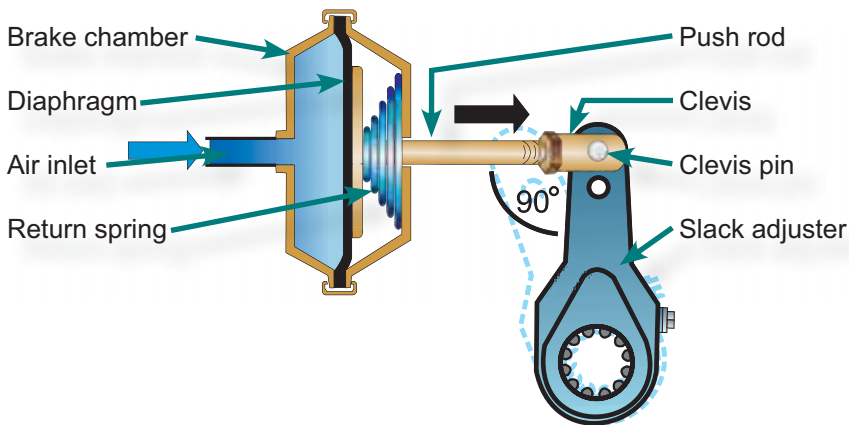

Front brake chambers are usually smaller than those in the rear because front axles carry less weight. A brake chamber is usually mounted on the axle, near the wheel that is to be equipped for braking. Air pressure is fed through an inlet port. The air pushes against the diaphragm and the push rod. The push rod is connected by a clevis and pin to a crank arm type lever called a “slack adjuster.” This converts the pushing motion of the push rod from the brake chamber to a twisting motion of the brake camshaft and S-cams. When the air is exhausted, the return spring in the brake chamber returns the diaphragm and push rod to the released position.

2

As indicated by its name, the slack adjuster adjusts the “slack” or free play in the linkage between the push rod and the brake shoes. This slack occurs as the brake linings wear. If the slack adjusters are not adjusted within the limitations, effective braking is reduced and brake lag time is increased. If too much slack develops, the diaphragm will eventually “bottom” in the brake chamber, and the brakes will not be effective.

Slack Adjuster (Manual)

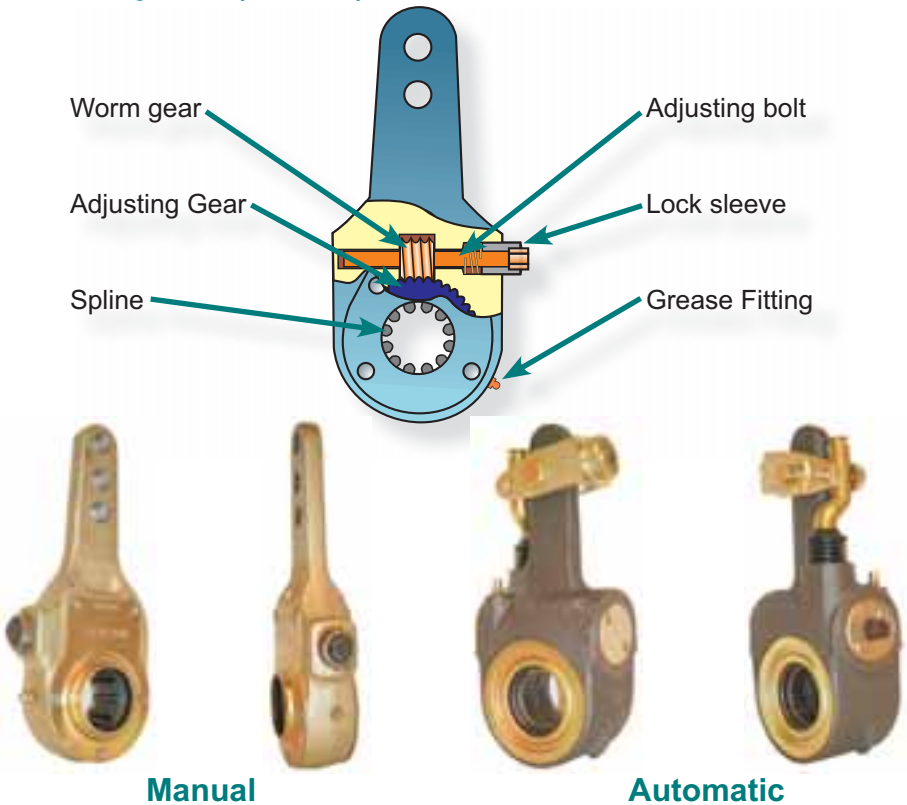

Previously illustrated was a common type of manual slack adjuster, showing the worm adjusting gear. Following the illustration were pictures of a common manual and an automatic slack adjuster available today. When the brakes are fully applied, the angle between the push rod and the arm of the slack adjuster should be no more than 90° (at a right angle).

Brake Chamber and Slack Adjuster (Brakes applied)

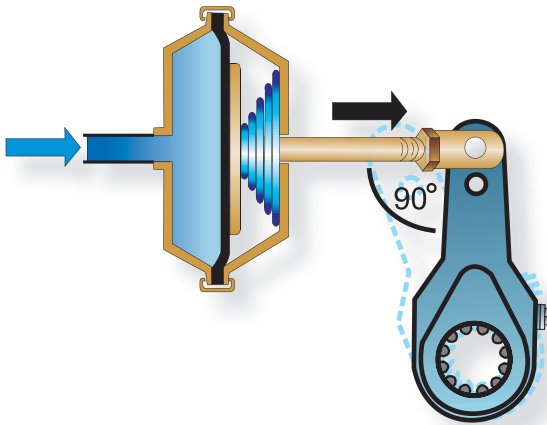

On manual slack adjusters, the adjusting worm bolt is turned until the brake linings touch the drums and then backed off, normally $1/4$ to $1/2$ a turn. A locking device, which may be a spring loaded collar over the head of the adjusting bolt, must be depressed when the wrench is slipped over the bolt head, this is known as a positive lock slack adjuster. Or they could use a spring-loaded internal check ball to lock the adjustment, and it must be removed to make any adjustment. This is known as a ball indent slack adjuster. The more often the driver checks the “slack,” the less the probability of brake failure. Vehicles rarely

2

“lose” their brakes because of air loss; it is usually because they are out of adjustment.

When conducting a pre-trip air brake inspection look for worn or damaged components, also ensure that the slack adjuster and push rod are at 90° with the brakes applied, as illustrated. If more than 90° there is a drastic loss in braking efficiency, less than 90° may indicate an over adjustment and brakes could be dragging.

It is the driver’s responsibility to ensure the braking system is operating properly and the brakes are adjusted correctly. A simple service brake application at low speed to check brake adjustment is not adequate. Braking at highway speed causes brake drum expansion due to heat, which in turn requires greater push rod travel to maintain the same braking force. If a brake is out of adjustment there would not be enough reserve stroke of the push rod travel to compensate for drum expansion. This would cause a brake fade and would greatly extend stopping distance. If travelling down a hill, this could cause complete brake loss.

Some systems have automatic slack adjusters that adjust automatically to compensate for brake lining wear, usually maintaining the correct clearance between the brake lining and drum. Automatic slack adjusters must be checked regularly to ensure that correct adjustment is being maintained. There are various makes and models of automatic slack adjusters in use. Primarily, they are either stroke-sensing or clearance-sensing. A stroke-sensing adjuster will adjust the slack when it senses the set stroke is exceeded. A clearance-sensing adjuster will adjust

when the proper clearance between the brake drum and brake shoe is not maintained. Some automatic slack adjusters have the ability to back-off or increase the slack when it has over adjusted the brake. If a vehicle is equipped with automatic slack adjusters, **it should not** be taken for granted that the brakes will always be in adjustment. The system is not foolproof. A number of factors could result in the automatic slack adjuster not maintaining proper slack. There could be improper installation, inadequate maintenance, deformed brackets, worn cam bushings, bent push rods. Even poor visual inspection can result in problems unrelated to adjuster function. Automatic slack adjusters can malfunction and not keep the brake in adjustment, especially when it has been in service for a long period of time. The two most common problems are excessive premature wear and internal contamination. As an automatic slack adjuster ages in service, the components wear that sense when an adjustment is required. The result is more stroke is required for the lining to contact the brake drum, and if not checked the brake could be out of adjustment. If even a small amount of water is sucked into an automatic slack adjuster mechanism it can cause corrosion or, in winter, it can freeze the internal sensing components and inhibit or prevent adjustment. Also, under certain conditions, an automatic slack adjuster that does not have the ability to back-off or increase slack, may over adjust a brake causing it to drag. For example this could take place when a tractor-trailer is negotiating a long, curving downgrade. The driver should “snub” the brakes, which is repeatedly applying the brakes moderately to maintain safe control of the vehicle. However it would not take long in this severe braking condition for one or more of the brake drums to overheat and expand. The overheating will physically increase

2

the brake drums diameter, and in extreme and prolonged conditions will lead to longer push-rod strokes to achieve the braking force required. The automatic slack adjuster interprets this as a need for adjustment and will take up slack. When the brake drum cools down and returns to normal size the brakes are over adjusted and dragging. At that time the driver should stop and check the brakes for adjustment. A number of full brake applications per day may be required to keep the automatic brake adjusters in adjustment.

Because automatic slack adjusters are not foolproof, it is important the operator of a vehicle equipped with automatic slack adjusters be able to manually adjust them. **For information on manually adjusting the automatic slack adjusters on your vehicle consult the manufacturer.**

Illustrated is a common type of foundation brake assembly used on truck rear axles and trailer axles. A front axle assembly has the brake chamber and slack adjuster mounted on the backing-plate because of the steering action.

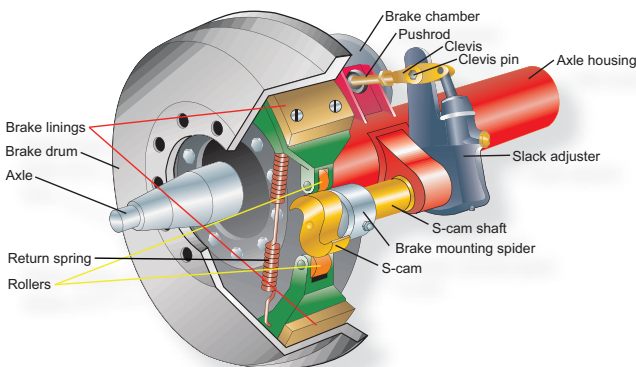

Brake lining material is attached to the shoes. The material used depends on the braking requirements of the vehicle. Brake lining must give uniform output of brake effort with minimum fade at high temperatures.

Fading or reduction in braking effort occurs when the heated drums expand away from the brake linings. The brake linings also lose their effectiveness with overheating.

The twisting action of the brake cam shaft and S-cam forces the brake shoes and linings against the drums. The brake linings generate heat from friction with the brake drum surface.

The thickness of the drums determines the amount of heat they are able to absorb and dissipate into the atmosphere. Drums worn thin will build up heat too quickly. Dangerously undependable brake performance will result from distorted drums, weak return springs, improper lining, poor adjustment, or grease or dirt on the lining.

Drums must never be machined or worn beyond the manufacturer's specification.

Wedge Brakes

Here is another example of a brake assembly used on some air brake-equipped vehicles. The action of the brake chamber push rod forces a wedge-shaped push rod between the brake shoe rollers. This forces the brake shoe lining against the brake drum. The vehicle may be equipped with a single or dual chambers on each wheel, depending on the vehicle's size and style.

2

Wedge Brake

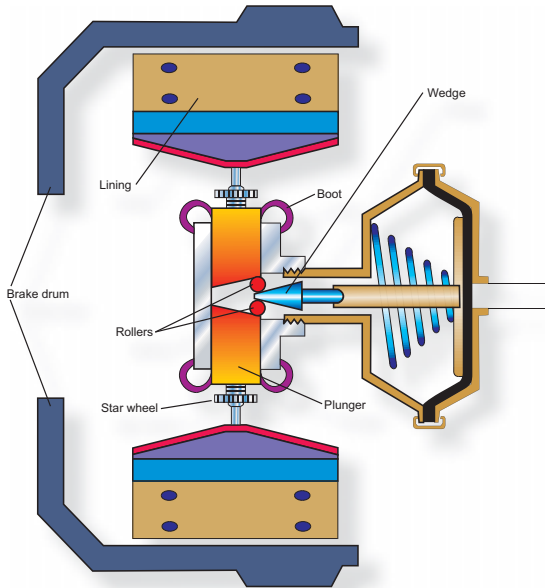

These brakes may be equipped with a self-adjusting mechanism or with a manual “star wheel” adjuster. The star wheel adjustment is made with the vehicle jacked up, to insure that the brake linings do not drag. Manual adjustment of wedge brakes is usually done by a qualified mechanic.

Disc Brakes

The air-activated heavy truck disc brake is similar in principle to that used on passenger vehicles. Air pressure acts on a brake chamber and slack adjuster, activating the brakes. Instead of the cam or wedge used in conventional heavy truck drum brakes, a “power screw” is used. A power screw works like a C-clamp, so that the lining pads exert equal force to both sides of the disc or rotor. Some types of disc brakes have a built-in

automatic adjuster. Disc brakes that require manual adjustment have adjustment specifications that differ from conventional S-cam braking systems. Always check the manufacturer's specifications before adjusting. Disc brake assemblies may have a spring parking brake unit attached to the service brake chamber.

Disc Brake

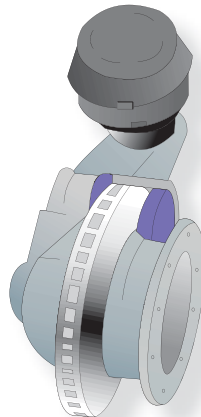

Air-Over-Hydraulic Brake Systems

Air-over-hydraulic brake systems were developed for medium weight vehicles because:

- diesel engines do not have a source for vacuum boosting unless they are equipped with a vacuum pump.
- medium weight vehicles do not require a full air brake system.
- it gives the option of pulling an air brake equipped trailer.

These systems combine the best features of an air and hydraulic brake system. They use hydraulic brakes at each

2

wheel with their reliable self adjusters and limited maintenance. On these systems the air is used to either actuate the hydraulic brakes or boost the hydraulic brake pressure as explained in the following.

Air-Actuated Hydraulic Brake System

(Air Brake Endorsement Required)

An air-actuated system usually has the same components of a standard air supply system including a warning buzzer and light, compressor, governor, supply and dry reservoirs, and a foot valve that could be a single or dual type. These components are found usually in the same places as on a full air brake system. Also there are one or two air actuated hydraulic pressure converters depending on if the system is a single or a dual system. This system consists of an air chamber or cylinder attached to a hydraulic master cylinder. When the foot valve is depressed, the air pressure actuates the pushrod from the air unit that pushes against the master cylinder piston, producing hydraulic pressure directed through tubing to the wheel cylinders actuating the front and rear axle service brakes.

It is essential that the operator of such a vehicle have knowledge of air pressure build up time, governor loading and unloading pressure, warning device operation, and how to drain air reservoirs properly.

Each vehicle manufacturer may have different parking brake applications, either automatically when air pressure is reduced in the reservoir, or mechanically by a brake on the rear of the transmission, or with the rear brake system. Since hydraulic brake systems actuated by air pressure are regarded as an

air brake system, your driver's licence must have an air brake endorsement for you to operate vehicles equipped with air-activated hydraulic brakes.

Air-boost Hydraulic Brake System

(Air Brake Endorsement not Required)

An air-boost hydraulic brake system uses air pressure to assist brake force. This is similar to vacuum-assisted brakes on most passenger vehicles. An air-boost system usually has the same components of a standard air supply system including a compressor, governor, wet and dry reservoirs. These components are found usually in the same places as on a full air brake system. The brake pedal linkage operates a hydraulic master cylinder that sends hydraulic pressure to the booster unit. Initially, at low pressure the hydraulic fluid passes through the booster and begins to pressurize the wheel cylinders moving the brake shoes out to the drums. These booster units are similar in operation to "Hypower" or "Hydrovac" vacuum boosters found on most light and medium weight vehicles, but air pressure is used to intensify the hydraulic pressure generated by the master cylinder rather than vacuum. Built into the booster unit is a hydraulically operated air control valve. This is where air from the reservoir is directed. As the pressure from the master cylinder increases, the air control section in the booster will open and begin to deliver air pressure to the rear of the air cylinder. The air cylinder pushrod transfers pressure on a piston in the hydraulic section of the booster, increasing the hydraulic pressure at the wheel cylinders.

The driver has full control of the braking force as the air control section modulates the boost pressure in proportion to the

2

master cylinder pressure. If the vehicle was to lose all of the air pressure the brake system would lose the air assist boost, however the hydraulic system would continue to work but at reduced effectiveness. An air brake endorsement on a driver's licence is not required to operate a vehicle with this brake system. Consult the operator's manual for the vehicle you drive for maintenance requirements.



Chapter 3

NWT Air Brake Manual

HOW THE BASIC
SYSTEM WORKS

3

How the Basic System Works

Basic Air Brake System (Single Circuit Only)

Air is pumped by the compressor to the supply reservoir, which is protected from over pressurization by a safety valve. The governor controls the pressure in the reservoir to the bottom of the foot valve. The driver pushes the foot valve treadle down and air pressure flows to the front and rear brake chambers. The brake chamber push rods move the slack adjusters. The slack adjusters rotate the S-cams, forcing the brake shoes against the drums. This causes friction that stops the wheels. The driver releases the foot valve treadle and the air in the brake chambers is allowed to exhaust through the foot valve, releasing the brakes.

The following explains the additional components of a basic air brake system. Other valves which are necessary to ensure smooth and efficient operations are not included in this simple drawing. They will be discussed later in the manual.

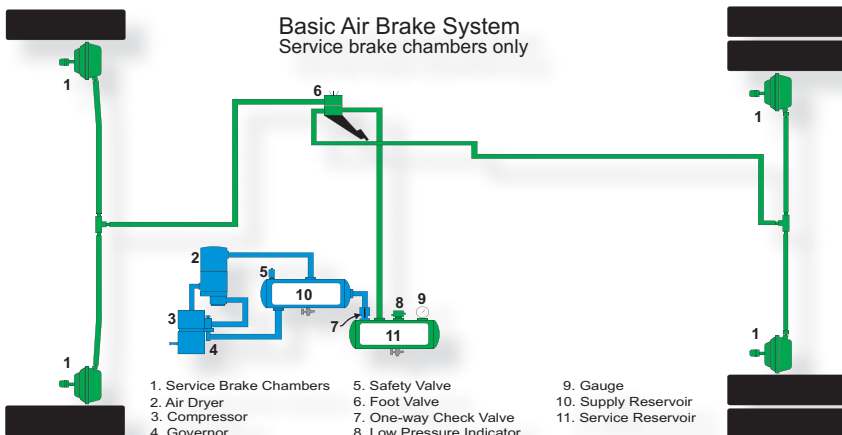

One-Way Check Valve

In the previous diagram, two reservoirs are shown. To prevent air from flowing backwards in the system toward the compressor, a one-way check valve is installed between the reservoirs. This valve allows the air to flow in one direction only. The valve is spring loaded. Pressure at the inlet side overcomes the spring pressure and lifts the check valve ball, or disc, off its seat. Air passes through the valve to the outlet. When pressure at the outlet becomes greater than at the inlet - together with the spring pressure - the check device seats, preventing air from flowing back through the valve.

One-Way Check Valve



Air Pressure Gauge

Vehicles with an air brake system are equipped with a reservoir air pressure gauge. This gauge is mounted in the cab, usually on the dashboard, and indicates the air pressure in the primary and secondary or service reservoirs. The supply reservoir does not usually have an air pressure gauge. Common operating pressures are 80 to 135 psi, depending on the system. Monitoring the gauge will alert the driver to any unusual changes in air pressure. There two gauges on vehicles today,

3

one is for primary air pressure and the other for secondary air pressure. Sometimes both of these gauges will be combined into one. The terms primary and secondary will be discussed later in this manual.

Air Pressure Gauges

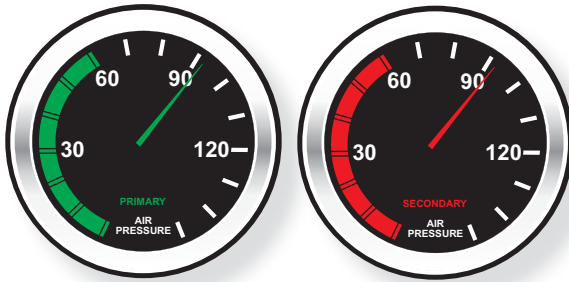

Brake Application Gauge

An additional gauge can be installed on the dash to indicate the application air pressure when the brakes are applied. This gauge can be piped to indicate the pressure of either a foot or hand application. (Hand application will be explained later in the manual.)

Brake Application Gauge

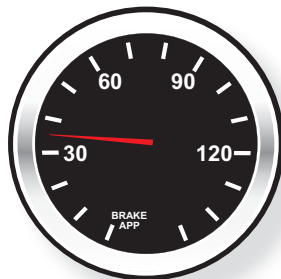

Low Pressure Warning Device

All vehicles equipped with an air brake system must have a device to warn the driver if the air pressure in the system drops to a dangerous level. This device must be comprised of two systems - visual and audible - consisting of a red warning light and a buzzer or a wig wag. Due to overuse or leaks, the low pressure indicator switch will turn on a red warning light on the dash or cause a buzzer to sound at or before 60 psi. Some vehicles are equipped with both a light and a buzzer to warn the driver of a low air pressure condition. If the vehicle was manufactured with both a visual and an audible warning device, they must be kept operational or the vehicle could be placed Out-of-Service in North America.

Stop Light Switch

Any driver following your vehicle must be warned when reducing speed or stopping the vehicle. The stop light switch is an air-operated electric switch that turns on the brake lights at the rear of the vehicle when a brake application is being made.

Quick Release Valve

The application of the brakes in the basic system was described earlier. In a basic system, when the driver releases the foot valve, it would be necessary for the air under pressure in the brake chambers to return to the foot valve to release the brakes. This releasing action would be slowed in long wheel base vehicles because of the longer lines between the foot valve and the rear brake chambers. To allow the brakes to release quickly and fully by discharging the application air near the brake chambers, a quick release valve may be installed.

3

Quick Release Valve

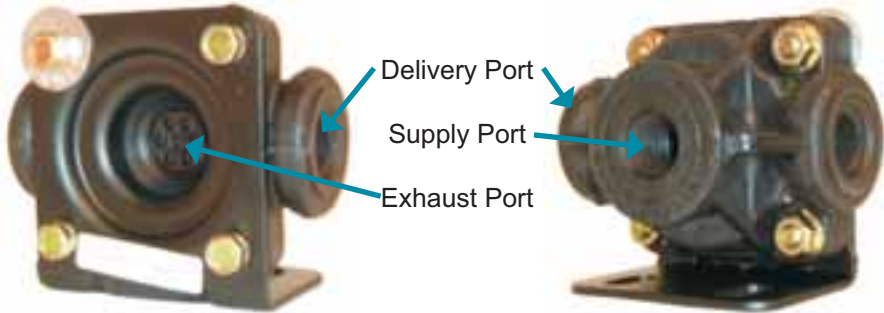

Relay Valve

The foot valve is usually located closer to the front wheels than to the rear wheels. The longer the distance from the foot valve to the rear chambers, the more time it will take before the rear brakes apply. This is known as brake lag. To correct this condition on a long wheel base vehicle, a relay valve is installed near the rear brake chambers. A larger diameter pipe is connected between the main reservoir and the relay valve. The air line from the foot valve to the relay valve now becomes a “control line.” (The air in the control line “dead ends” at the relay valve.) When the foot valve is depressed, the air pressure in the control line acts on the top section of the relay valve, relaying reservoir air directly to the rear brake chambers through the larger diameter pipe. The pressure of the reservoir air delivered in this way will be the same as the control pressure delivered by the foot valve. Releasing the foot valve exhausts the control air to the relay valve, allowing it to cut off the flow of reservoir air to the rear chambers. This in turn exhausts the air in the brake chambers by the quick release feature of the relay valve.

Relay Valve

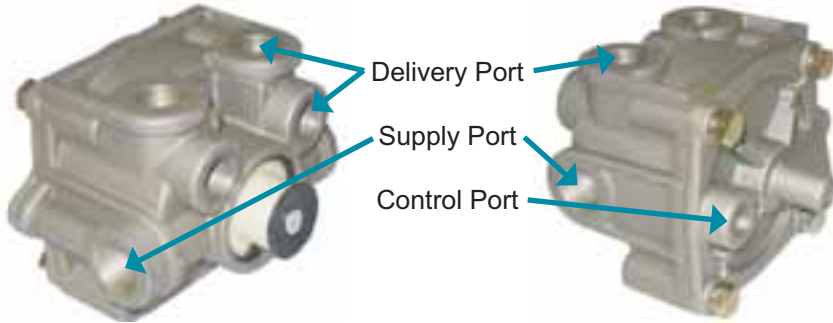

Front Wheel Limiting Valve

For better steering control on a slippery road surface, it can be an advantage to reduce the braking effort to the front wheels. This can be accomplished by installing a control valve in the cab, and a front brake limiting valve on the front axle.

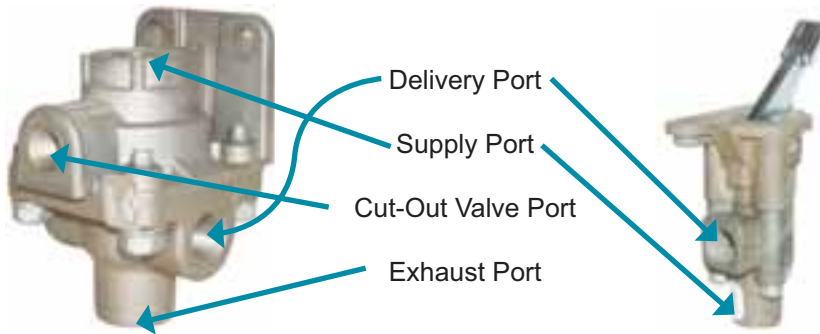

Manual Front Wheel Limiting Valve

The control valve is set in the “normal” position for dry road surfaces and the front braking application air pressure is normal. On a slippery road surface, the control valve is set to the “slippery road” position. In this position, the control valve will

3

cause the limiting valve to operate. Applying air pressure to the front brakes is then reduced to 50 percent of the application air pressure being delivered to the rear brake chambers.

Some systems are equipped with an automatic limiting valve.

Automatic Front Wheel Limiting Valve

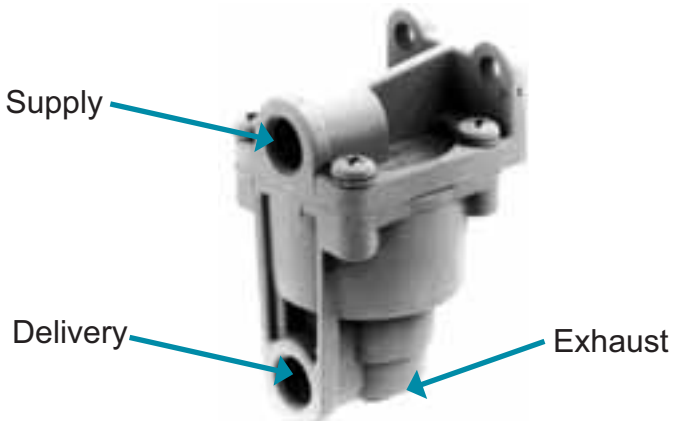

This valve will hold off brake application to the front wheels from 0 to 10 psi, depending on how it has been preset. Between the preset pressure and 40 psi of brake application, the reduction is approximately 50 per cent. Brake applications between 40 psi and 60 psi are reduced by less than 50 per cent. Brake applications more than 60 psi are not reduced and full application is directed to the front wheels.

The following two diagrams build on the previous one of the Basic Air Brake System. On both these diagrams, an air line has been plumbed in from the service reservoir directly to the rear brake chambers through the added relay valve. The

line from the foot valve to the rear brake chambers is also connected through the relay valve and now becomes the “control line”. The first diagram shows the plumbing for the manual front limiting valve that requires the in cab control valve and the second illustrates the automatic front limiting valve.

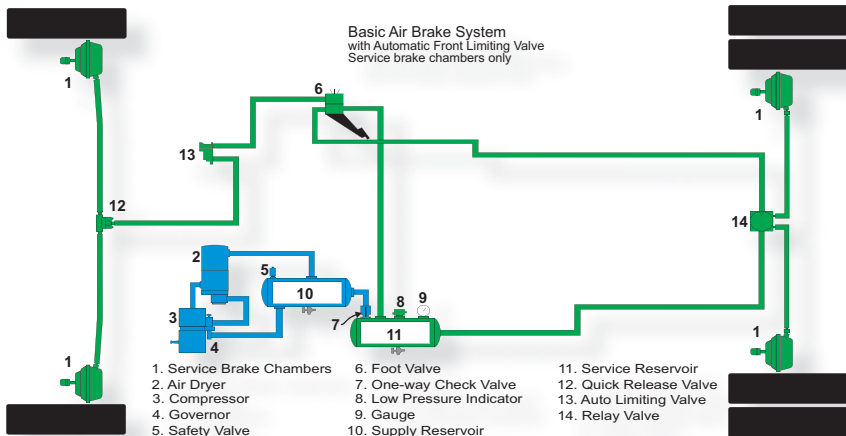
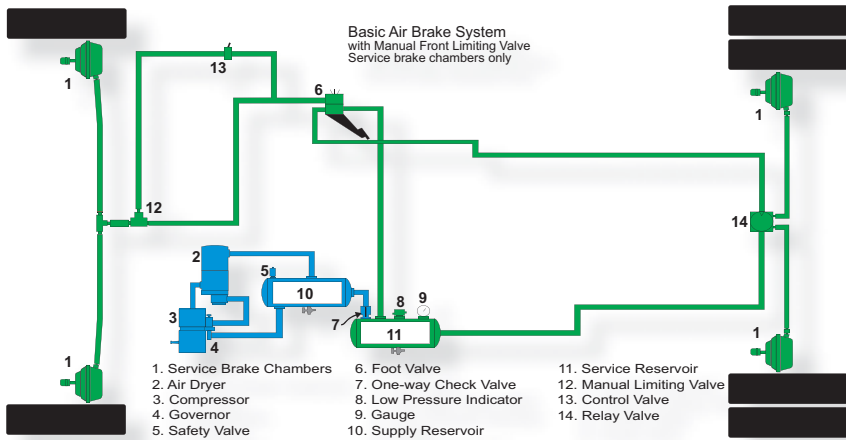

Chapter 4

NWT Air Brake Manual

**SPRING PARKING
BRAKES**



4

Spring Parking Brakes

Parking Brakes/Spring Brakes (Single Circuit Only)

Spring parking brakes may be installed on an air brake equipped vehicle for use as a reliable parking brake system. In the service brake system, the brakes are applied by air pressure and retracted by springs. In the spring parking brake system, the brakes are applied by spring pressure and retracted by air pressure. The spring parking brake chambers are attached to the service brake chambers and operate through the same linkage, therefore the effectiveness of the spring parking brake depends on the service brake adjustment. A control valve (operated by a square, yellow button) located in the cab allows the driver to exhaust air out of the spring parking brake circuit to apply the brakes, or pressurize the circuit to release them. Some systems may have an additional valve controlled by a blue button that applies only the tractor spring parking brakes and not the trailer spring parking brakes. The system can also act as an emergency brake. Loss of air from the system may automatically apply the brakes, depending on how the system is piped.



A spring-loaded valve requires that the valve be pushed in to release the spring parking brakes. This valve cannot be left in the released

position below approximately 35 psi in the system. Any time the reservoir pressure drops to approximately 35 psi, this valve will exhaust automatically, placing the spring parking brakes into full application. On some older vehicles there may be a single type of pushpull control valve that does not have an automatic release feature. To apply the spring parking brakes, the valve must be operated manually, even though the reservoir pressure has been depleted.

Control valves will vary, depending on the manufacturer and type of piping arrangements.

During normal operation, air pressure cages (compresses) the parking brake spring, holding it in the released position ready for parking or emergency braking.

Spring Brake Chamber - Brakes released with Supply Air

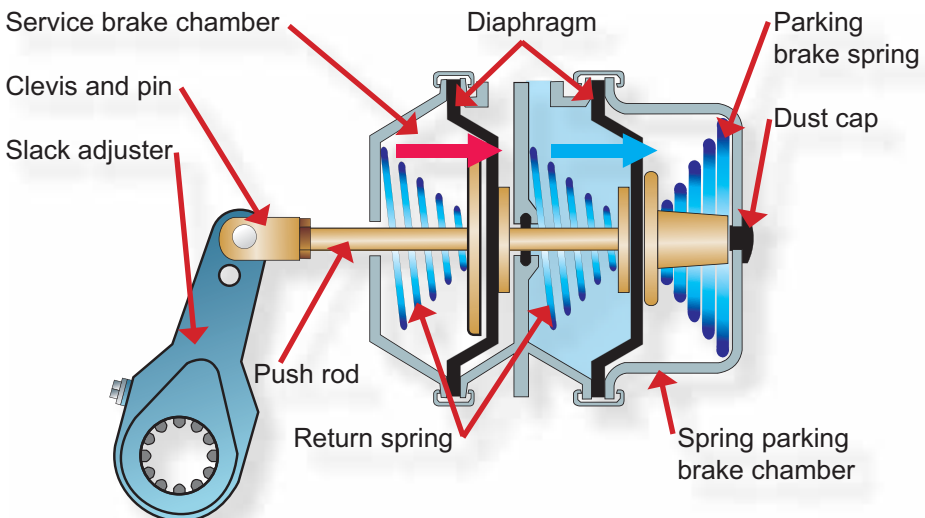

4

During normal service brake operation, the parking brake spring does not expand. Air pressure keeps the spring caged.

Spring Brake Chamber - Service Brake Applied, Park Brake Released

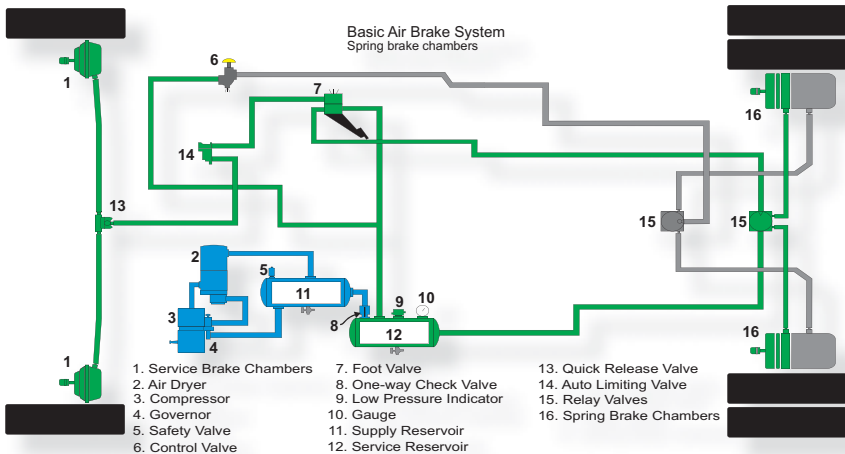
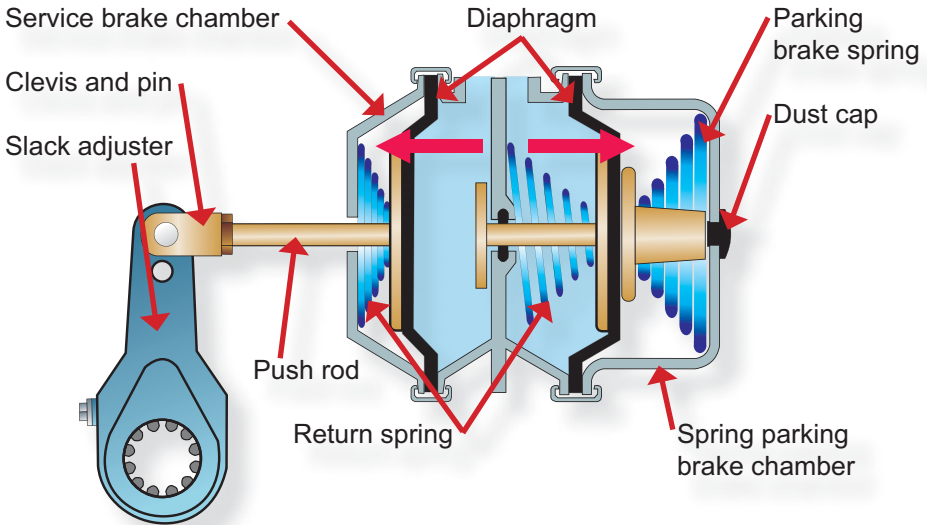

Spring parking brakes, added to the brake chambers of the rear axle on the single unit vehicle, are illustrated on the previous diagram. A control valve is mounted in the cab.

A supply line of reservoir air is piped from the service reservoir to the control valve. Opening the control valve allows reservoir air pressure to flow to the spring parking brake chambers, releasing them.

Closing the control valve shuts off the supply of reservoir air pressure and exhausts the existing pressure in the spring parking brake chambers. This motion allows the spring to expand, applying the brakes.

Caution: Parking brakes should be in the release position before making a service brake application. A full-brake application, made when the parking brakes are applied, can compound the force exerted on the slack adjusters and linkage and result in damage or brake failure. Compounding is the combination of two forces: the force applied by the spring brakes and the service brake.

Spring brakes are primarily used as a parking brake, but in the event of loss of air pressure in the system, they can assist in stopping the vehicle. How quickly they will stop the vehicle depends on such factors as:

- the weight and speed of the vehicle;
- the steepness of the grade;
- the spring force of the spring brakes that have been installed; and,
- the adjustment of the service brakes.

4

Spring Brake Chamber - No Air Supplied, Spring Park Brake Applied

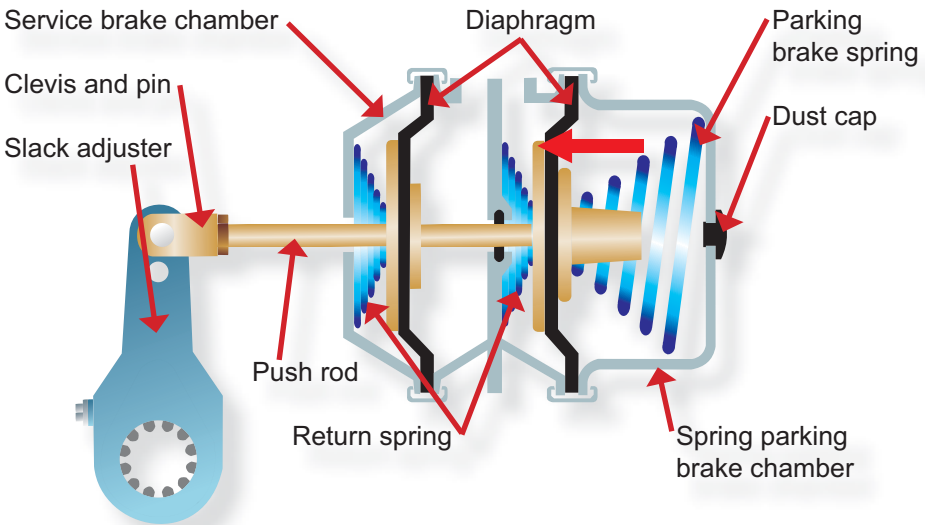

If the brakes have overheated, such as during mountain driving or hard highway braking, care must be taken when parking the vehicle. If the spring parking brakes are applied when the brake drum has expanded because of extreme heating, when the brake drum starts to cool and contract, the pressure exerted by the spring parking brake may cause the brake drum to crack or warp. When parking a vehicle with overheated brakes, park on level ground, stop the engine and leave the transmission in the lowest gear and block the wheels. Do not set the spring parking brakes until you have verified the brake drum is cool to the touch.

Dual Control Valve and Reservoir System

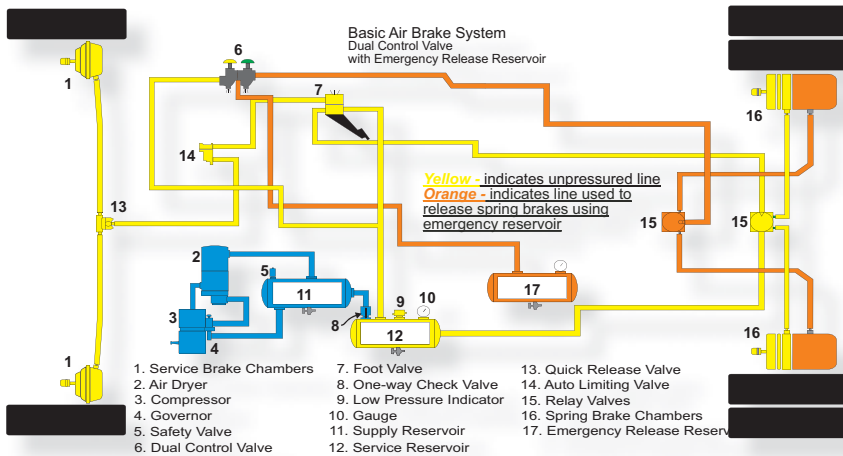

Some vehicles, such as buses, may also be equipped with an Emergency Release Reservoir (17).

In this system, if main reservoir pressure is lost, the spring brakes will automatically apply.

If the parking brakes have applied because of a loss of main reservoir air, the driver can draw reserve air from the emergency release reservoir (tank) to release the parking brakes. A dual parking brake control (6) is used together with the emergency release reservoir. The driver must press on the emergency release button. Releasing the emergency release button will automatically allow the parking brakes to re-apply.

The emergency release would only be used to move the vehicle from an undesirable location, if the parking brakes had been applied due to a low main reservoir air condition.

4

Mechanical Release (Caging)

Some spring parking brakes can be released mechanically by “winding them off” or “caging” them. Caging means the brakes are being released. This is achieved with a bolt that runs through the centre of the chamber body, which is turned to compress the spring. It may be necessary to first remove a lock plate and stud to gain access to the head of the bolt. Other types have a dust cap that must first be removed and a bolt inserted. In some cases, a special wrench is required. Instruction on how to “cage” is usually on the body of the parking brake chamber. If all air is lost and the vehicle has to be towed, the parking brakes can be released by caging them. Always block the wheels when caging the parking brake spring.

Spring Brake Chamber - No Air Supplied, Spring Park Brake Caged

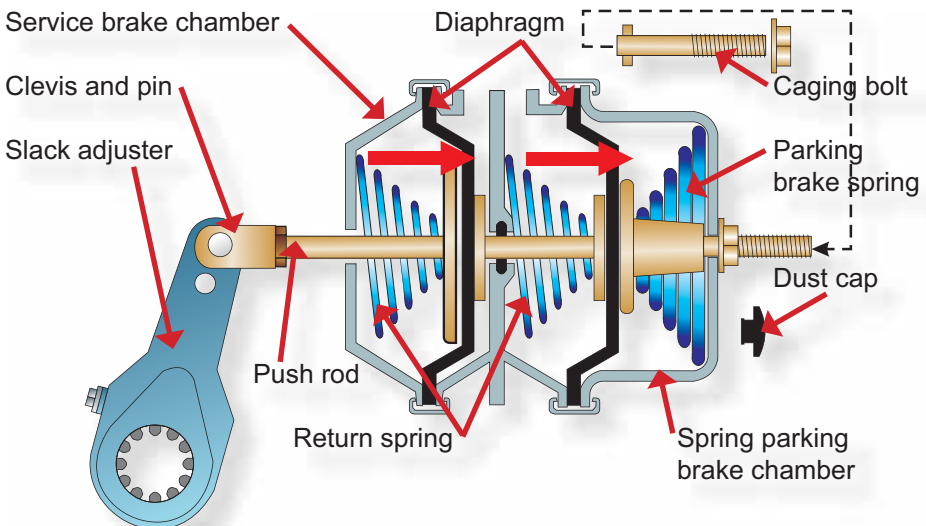

WARNING! Spring parking brake chambers should never be disassembled without first compressing the spring with a caging bolt. These springs are under extreme pressure and could cause serious personal injury if disassembly is attempted by anyone not experienced in servicing these units. Disassembly of a spring brake chamber should only be preformed by a qualified mechanic or technician.

Chapter 5

NWT Air Brake Manual

TRAILER SYSTEM



Information for the Reader

Throughout this section you will see these lines as illustrated above and below this paragraph. These lines are intended to group discussion. Therefore, everything between the lines is related to a specific topic to help you better focus your studies.

Trailer System

Trailer System (Single Circuit Only)

Up to this point, the system discussed is the air brake system of a truck or tractor. If a trailer was coupled to a truck or tractor, the brakes of the trailer would have to be operated from the truck or tractor.

In the following pages the power unit of a combination vehicle will be referred to as a tractor.

Glad Hands

This term refers to the coupling device used to connect the blue control (service) line and red supply (emergency) line of the tractor to the trailer. These couplers connect together and lock in position. They have rubber gaskets that prevent air from escaping at the connections.

Glad Hands



5

Before connection is made, couplers should be clean and free of dirt and grit. When connecting the glad hands, start with the two gaskets together and the couplers at a 90° angle to each other. A quick snap downwards will join and lock the couplers. Vehicles equipped with “dead-end” (dummy) couplers should use them whenever the vehicle is used without a trailer to prevent water and dirt from entering the coupler and lines.

“Dead End” (Dummy) Coupler



If the unit is not equipped with “dead-end” (dummy) couplers, the glad hand of the control (service) line can be locked to the glad hand of the supply (emergency) line to keep water and dirt from entering the unused lines. The cleaner the air supply is kept, the less chance of brake problems.



Glad hands and lines should also be secured to prevent the lines from chafing against vehicle components or bouncing off the vehicle. This could seriously damage the glad hands or lines. The picture to the left illustrates glads hands coupled to a “dead end” coupler permanently mounted on the rear of a tractor.

Application Line

The application line is referred to as a control (service) line. This line is connected to the foot and hand valve. When the driver depresses the foot valve treadle application air will be delivered to the tractor brake chambers and to the trailer brake chambers. When the driver releases the foot valve treadle, the application air to the trailer brake chambers must return to the foot valve to be exhausted to the atmosphere.

The disadvantages of this system are:

- if the trailer broke away from the tractor, the trailer would not have brakes.
- if the control (service) line parted or ruptured, the trailer brakes would not be applied, and the application air would be lost from the tractor if the brakes were applied.
- if the air pressure in the reservoirs is lost, there would be no way to apply the brakes of the tractor or the trailer.
- the trailer brakes cannot be applied independently from the tractor and there is no way to set the trailer brakes when coupling to the tractor.
- the application and release of the trailer brakes would be slower than those of the tractor.

These disadvantages are overcome by the addition of the supply (emergency) line and valves discussed in the following pages.

The next illustration shows the piping of a unit with brakes applied, similar to the tandem axles of the tractor. Also with brakes applied, the trailer has tandem axles equipped with brake chambers.

5

The application line has a “T” inserted between the foot valve and the tractor’s relay valve. An air line has been connected from this “T” to the trailer by a set of couplers (glad hands).

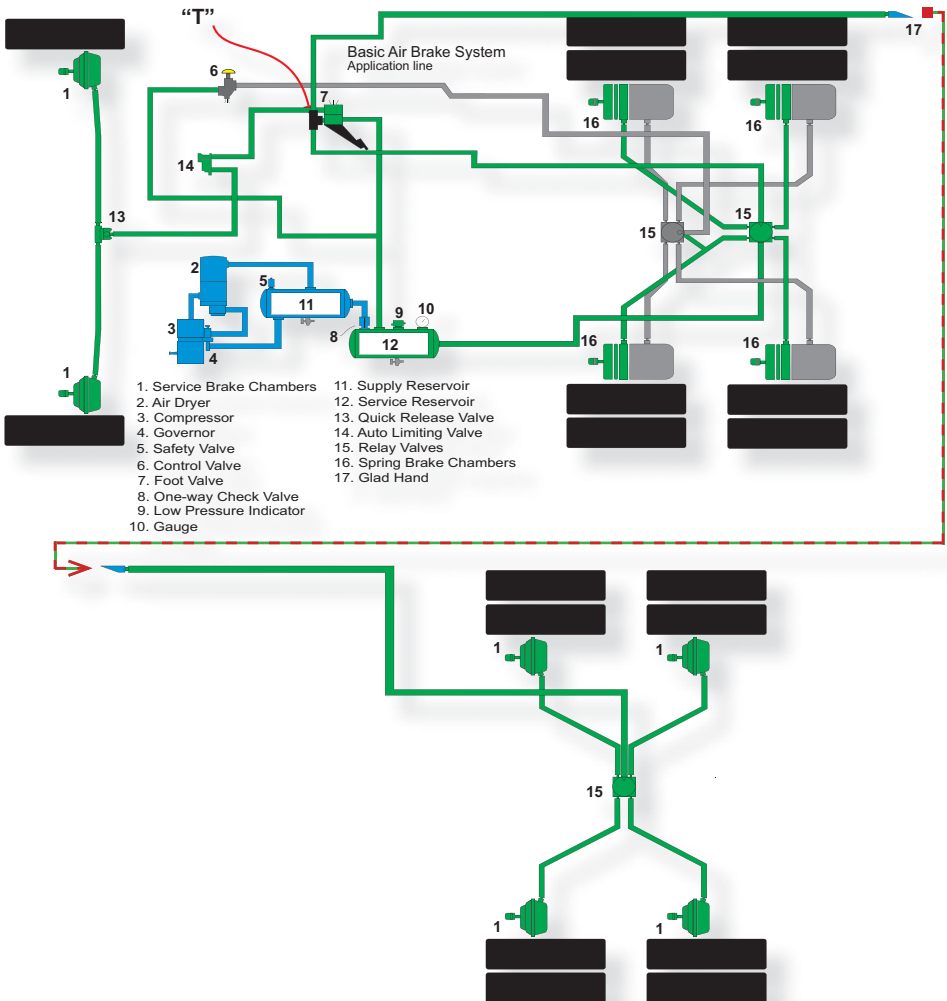

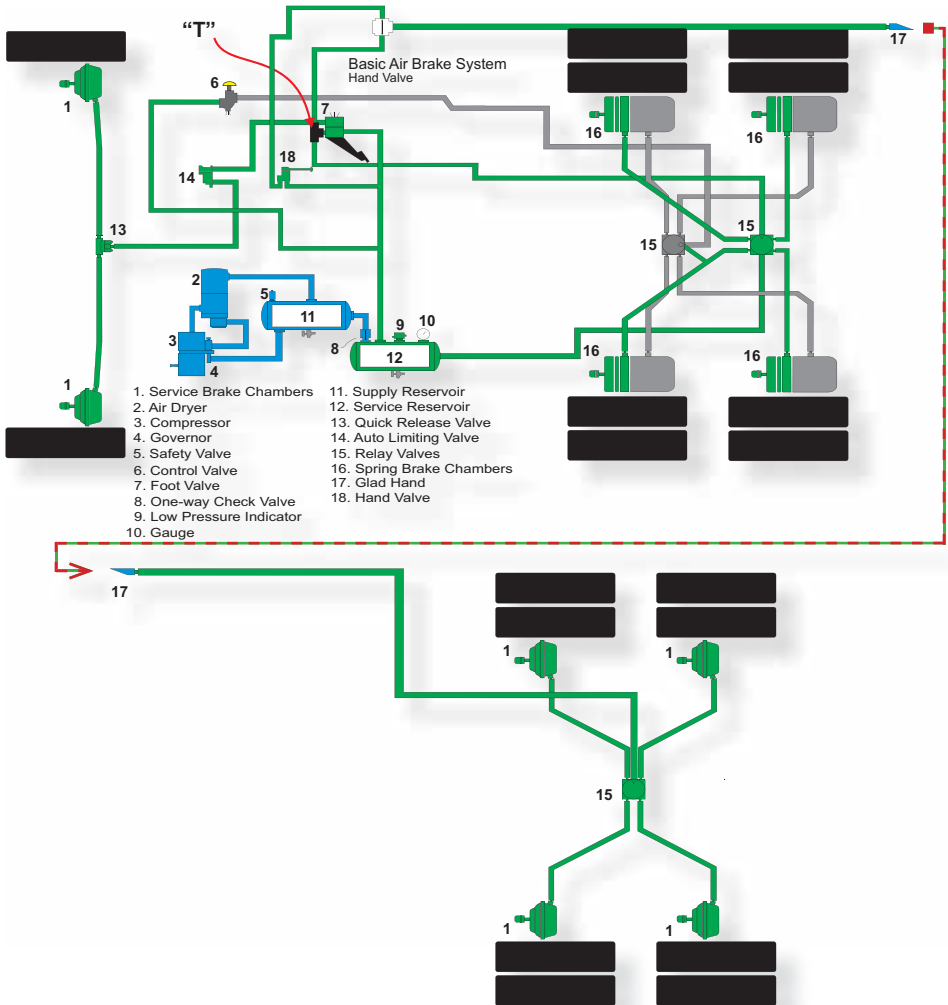

Hand Valve

The purpose of the trailer brake hand valve is to allow the driver to control independently the amount of application air pressure to be directed to the trailer brakes. It also provides

5

a method of applying the trailer brakes when coupling the trailer to the tractor. The valve also allows the driver to apply the trailer brakes independently of the tractor. The amount of application air pressure delivered depends on the amount the valve is opened by the driver. (It cannot exceed the reservoir air pressure.) Some valves are equipped with self returning handles.

Note: The trailer brake hand valve is not to be used for parking, as air may bleed off if the engine is stopped or the hand valve moves to the released position.

Trailer Hand Valve (Mounted on Steering Column)



Two-Way Check Valve

The purpose of a two-way check valve is to direct air flow into a common line from either of two sources. This valve will permit air to flow from the source that is supplying the higher application pressures. The shuttle will shift so that the higher pressure will be directed to the trailer through the control

(service) line. This valve is located between the foot-operated valve and the hand-operated valve.

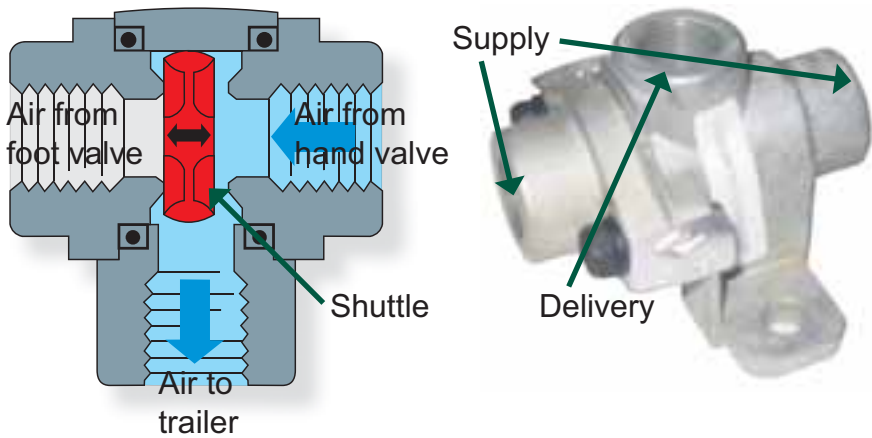

Two-Way Check Valve

The following two diagrams illustrate how the two-way check valve functions to divert air from the valve being used, whether it be the foot or the hand valve.

5

In the illustration below the driver has applied the brakes by using the foot valve (7). Application air is directed to the brake chambers of the tractor and to the trailer brakes through a two-

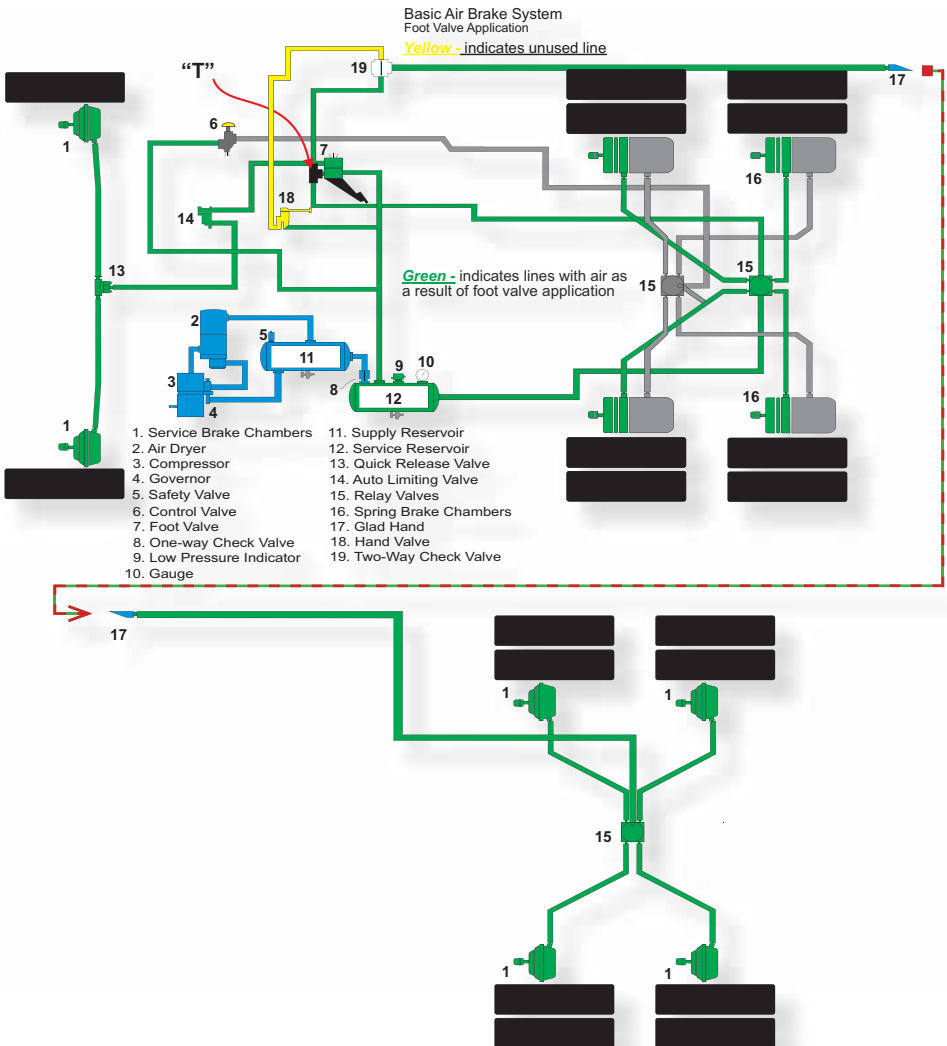

way check valve. The shuttle has shifted to the low pressure side, closing off any air flow toward the hand valve side. The hand valve is in the closed position and equal pressure is being applied to the brake chambers of the tractor and the brake chambers of the trailer.

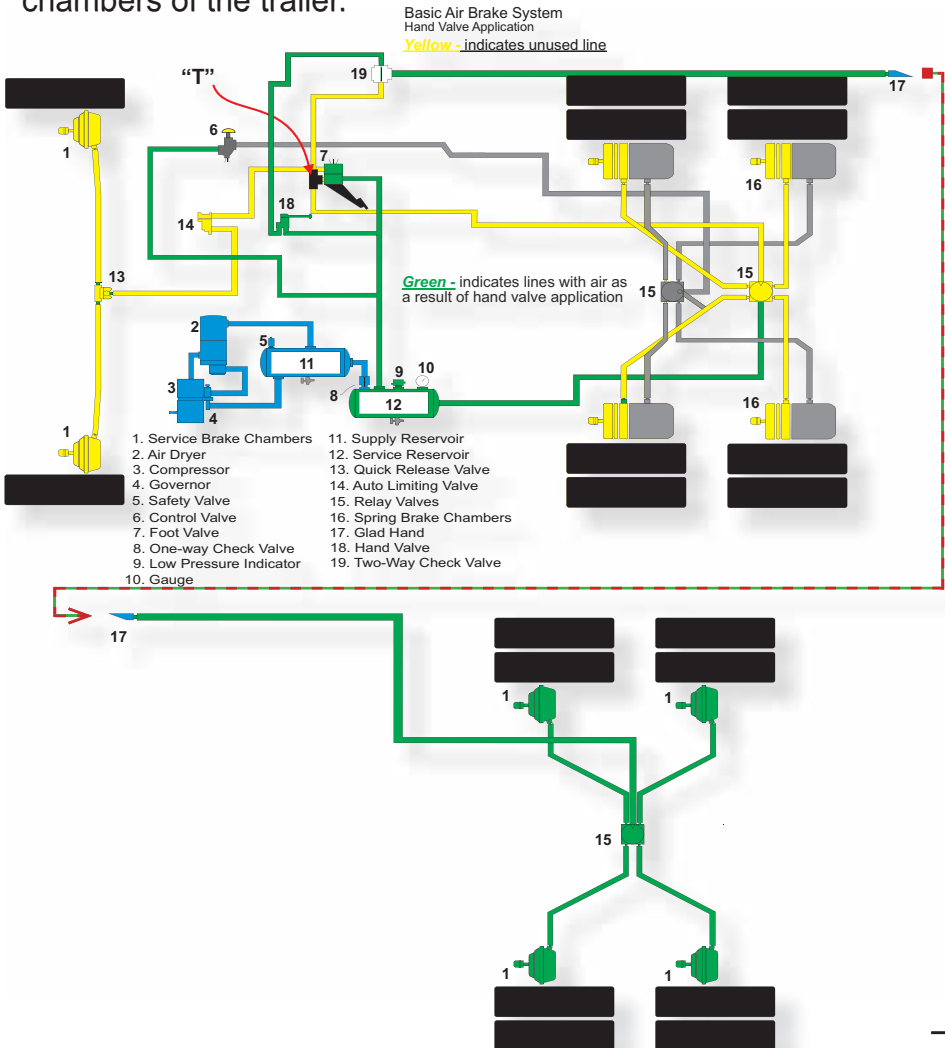

5

In the previous illustration with the foot valve released and the hand valve (18) opened, application air is directed from the hand valve through a two-way check valve, to the brake chambers. The two-way check valve in this application has shifted to the low pressure side, closing off any air flow toward the foot valve side.

Any time a trailer brake application is made using the hand valve, the driver may depress the foot valve treadle. If the foot valve application is of a higher pressure than that of the hand valve, the two-way check valve will shift to the lower pressure side, allowing the higher pressure to be directed to the tractor and trailer brakes. During a foot valve application, if the driver makes a hand valve application of a higher air pressure, the two-way check valve will direct the higher hand valve air pressure to the trailer brakes.

Although the trailer brakes may be applied independently by means of the hand valve, the maximum application pressure can only be the same as, or slightly less than, reservoir pressure.

Tractor Protection System

A tractor protection system prevents total loss of air from the tractor if the trailer breaks away, or if the connecting air lines between tractor and trailer become separated or ruptured. The tractor protection system consists of two valves: the tractor protection valve and the trailer supply valve. Other names for the trailer supply valve are “trailer parking control” and “emergency valve”.

There are two types of trailer supply valves. The most common is the automatic trailer supply valve. This is a spring-loaded valve that is opened manually and held open by air system pressure. The other is a manual trailer supply valve, which may be a toggle-type switch or a push/pull-type valve.

To understand the function of the trailer supply valve and the tractor protection valve in the system, it is important to understand how they operate.

Tractor Protection Valve

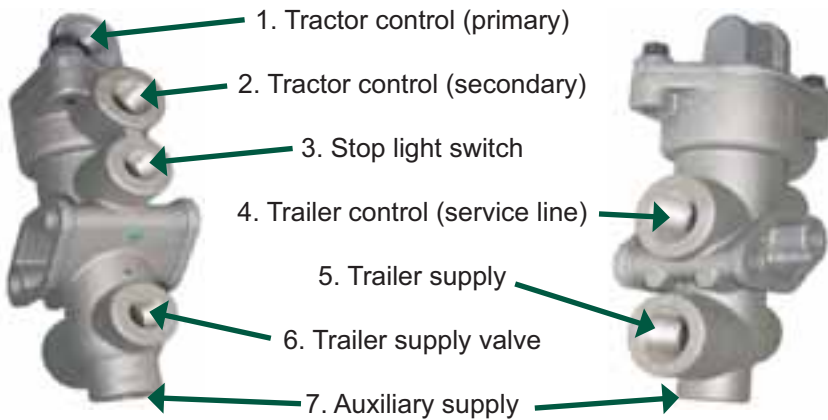

A tractor protection valve is normally located near the rear of the tractor cab and has two air lines running to it, one from the trailer supply valve (6) and the other from the two-way check valve (2) fed by the hand or foot valve. The valve illustrated above has a check valve and a brake light switch built into it. The foot valve and the hand valve tee together through a two-way check valve and run into port (2). The foot valve is plumbed directly into port (1) as well.

5

It also has two air lines: one coming from the supply (emergency) line (5), and one coming from the control (service) line (4). The tractor protection valve is spring-loaded and requires approximately 45 psi in the supply (emergency) line to open the valve. This allows control (service) air to pass through the control (service) line to the trailer while making a brake application. When air lines from the tractor are coupled to a trailer, the opening or closing of the trailer supply valve opens or closes the tractor protection valve. Disconnecting the supply (emergency) line between the tractor and trailer while the trailer is charged will cause loss of pressure in the supply (emergency) line on the tractor causing the tractor protection valve to close, which in turn closes off air flow to the control (service) line. In the event of a control (service) line rupture or disconnection between the tractor and trailer no action or air loss will take place until a brake application is made. Service air will be lost out of the disconnected or ruptured line causing the tractor's air pressure to drop. At approximately 45 psi the trailer supply valve will close causing an emergency application of the trailer brakes and the tractor protection valve to close. This will stop the loss of service air at the disconnected line.

The tractor protection valve also protects the tractor's service air from being lost during normal brake applications while operating the tractor without a trailer.

To test the proper function of the tractor protection valve, hook the tractor's air lines to a trailer, ensure the vehicle is secure and the wheels are blocked and release the parking brake. Verify that the system is at full pressure, charge the trailer by opening the trailer supply valve, make a brake application

and hold it, (use a hand brake valve if alone.) Disconnect the control (service) line (there will be a loss of air.) Now disconnect the supply (emergency) line. Control (service) air will stop immediately and supply (emergency) air should continue to be lost, depending on the system. Reconnect the supply (emergency) line and again service air will be lost.

This tests the proper opening and closing operation of the spring portion of the valve. A tractor protection valve with a broken return spring will not close the valve and will cause loss of air during normal brake applications if operating the tractor without a trailer.

Tractor Protection System

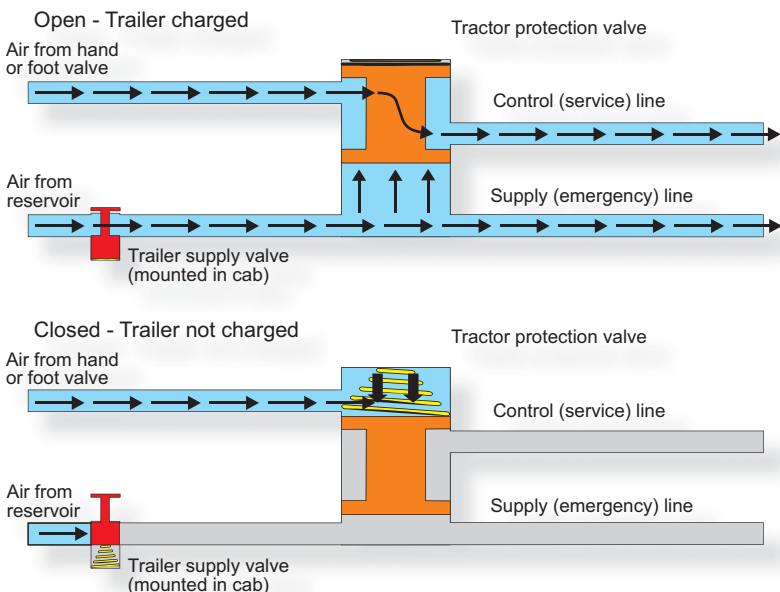

5

Trailer Supply Valve

This valve (usually a red octagonal button) is mounted in the cab of the tractor. The driver opens the valve by pushing or pulling the button, depending on the type used.

Opening the valve permits reservoir air pressure to flow through. This air pressure is piped to the tractor protection valve and then to the supply (emergency) line.



The valve is spring-loaded and will be held in the open position when sufficient pressure is reached. If the air pressure drops to a range between 45 and 20 psi, the valve will close automatically by spring pressure, opening the exhaust port. The driver can close the valve manually. This will open the exhaust port without the pressure being depleted from the tractor reservoirs. The spring parking brakes will also be applied.

Automatic Trailer Supply System

The next diagram illustrates air being piped from the service reservoir line to the trailer supply valve. The tractor protection valve is fed by two lines: one from the trailer supply valve and one from the two-way check valve. Leading off from the tractor protection valve are two lines, each with a glad hand coupler. These two lines are referred to as the control (service) line and the supply (emergency) line. The trailer is not coupled and the

tractor is being operated alone (“bobtailing”). The driver has not opened the trailer supply valve and the hand valve is closed.

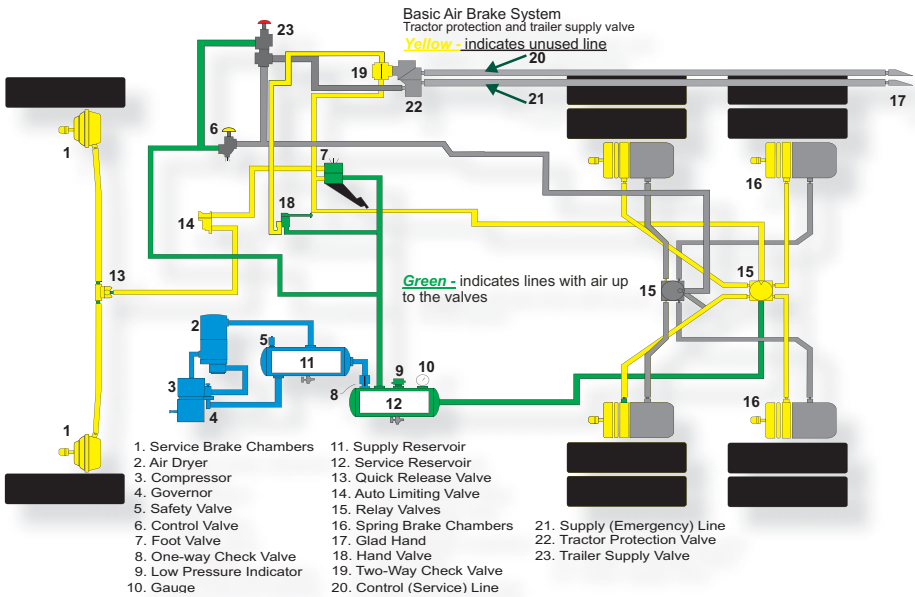

5

In this illustration, the driver has made a brake application with the foot valve and application air is being delivered to the tractor brake chambers. The two-way check valve has shifted to the low pressure side, allowing application air to reach the tractor protection valve. There is no air loss from the tractor through the disconnected glad hands because the trailer supply valve is closed.

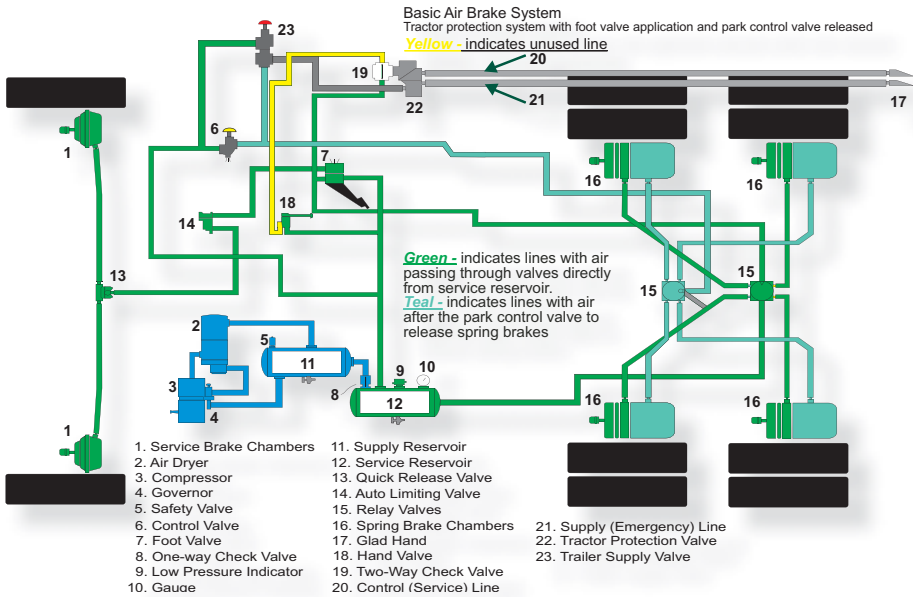

If the driver, by mistake, applied the hand valve with the trailer disconnected, the application air directed to the tractor protection valve would also be dead-ended. Again, no air loss would occur if the trailer supply valve is in the closed position.

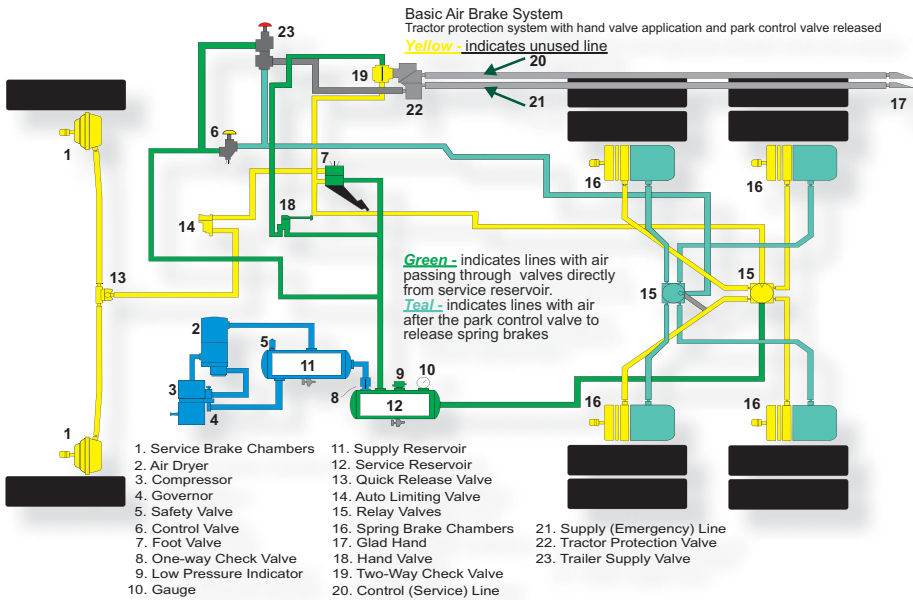

5

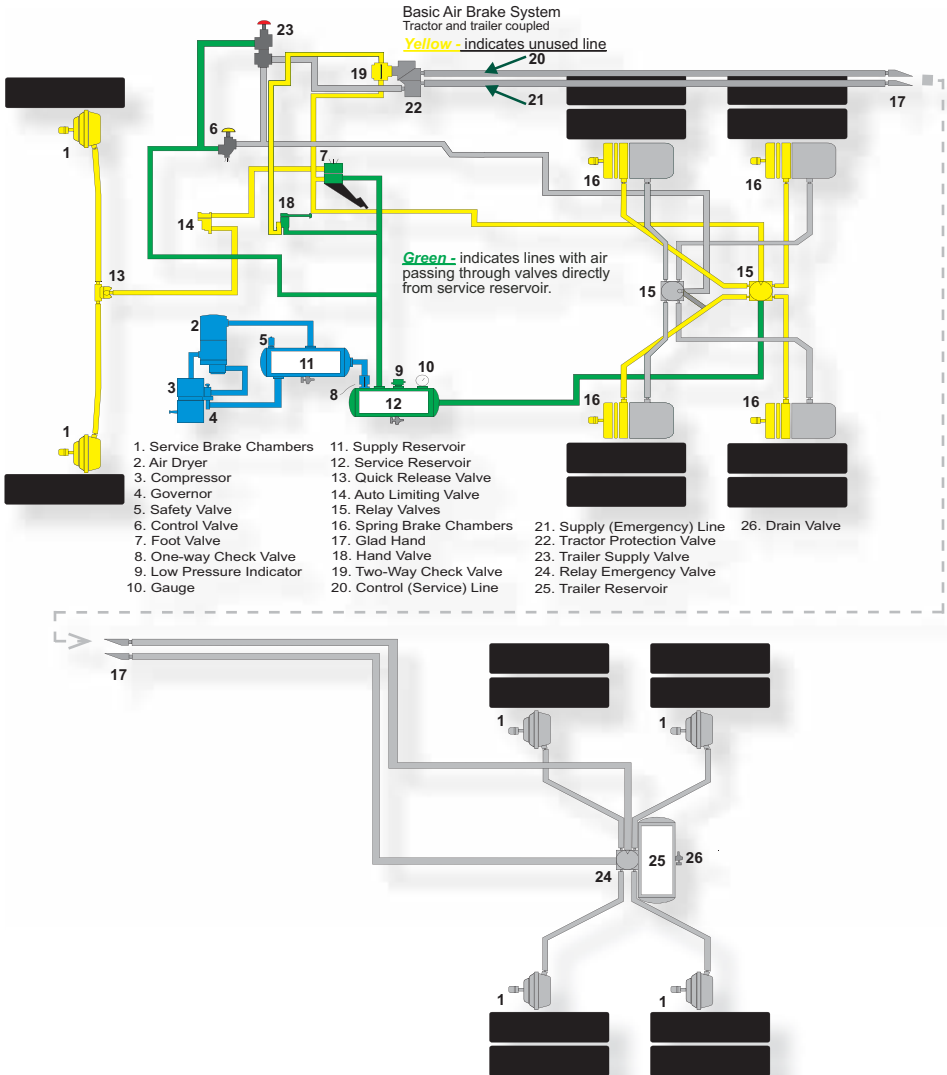

In this illustration, the trailer has been coupled to the tractor, and the control (service) and supply (emergency) lines have

been coupled using glad hands.

The trailer unit has a reservoir installed. This reservoir will provide a volume of air near the trailer chambers for normal or emergency braking. The trailer reservoir is fitted with a drain valve, the same as a tractor reservoir.

A relay emergency valve is mounted on the trailer reservoir or to the trailer frame near the brake chambers. The trailer reservoirs are filled through the relay emergency valve which serves three main functions in the system:

1. It relays air from the trailer reservoir to the trailer brake chambers during a brake application. This part of the valve operates like the relay valve previously discussed. It also provides a quick release of the trailer brakes.
2. It directs trailer reservoir air pressure to the trailer brakes, causing an emergency application of the brakes. This action will occur automatically in the event of ruptured or parted air lines between tractor and trailer, or loss of air pressure from the power unit service system. A ruptured control (service) line would not cause an emergency brake application on the trailer until a brake application was made, and this would cause a rapid loss of air pressure from the system. The driver at any time may operate the cab-mounted trailer supply valve to cause an emergency application of the trailer brakes.
3. It has a one-way check valve which stops air pressure in the reservoir from going back to the source of the supply.

5

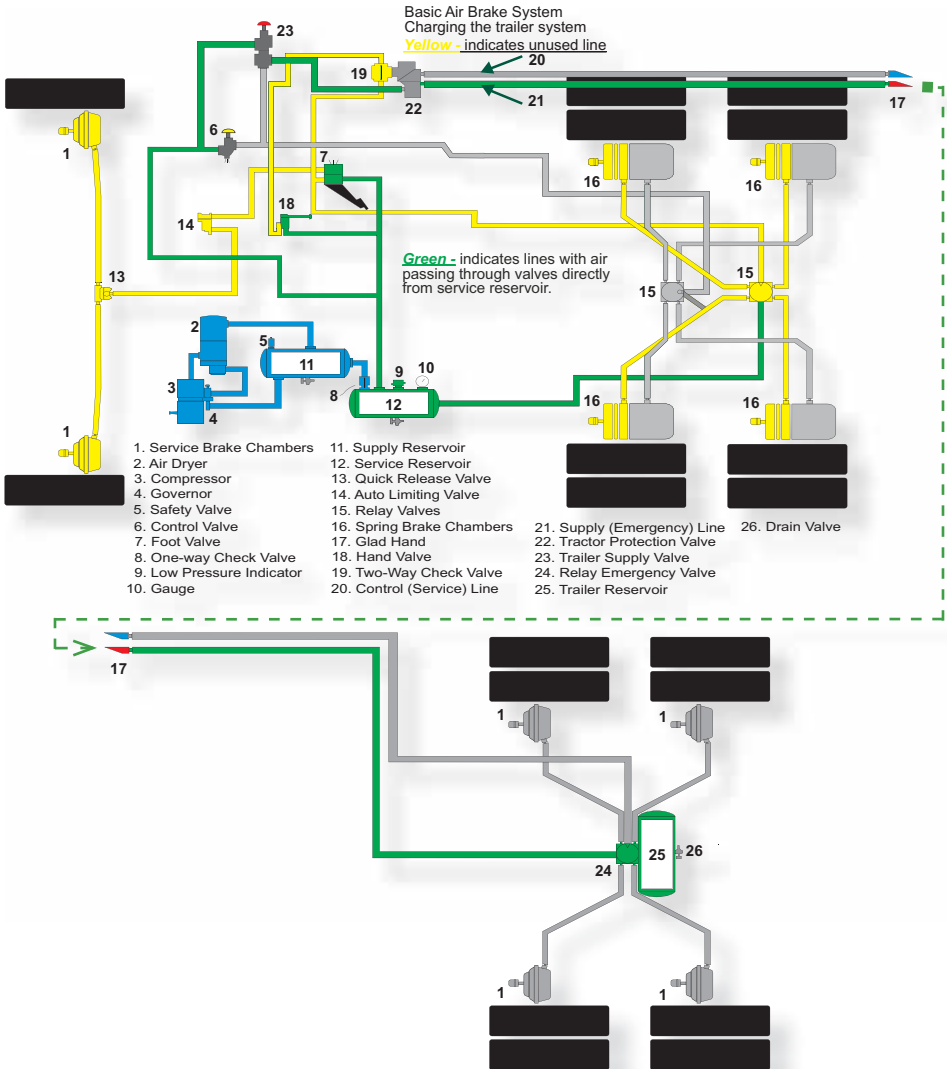

In the illustration, the compressor has raised the reservoir air pressure to maximum.

The driver has opened the trailer supply valve to allow the reservoir air pressure to be directed through the tractor protection valve to the trailer. The air pressure passes through the relay emergency valve to the reservoir on the trailer. Pressure will build up in the trailer reservoir to the same pressure as the reservoirs on the tractor. This is known as “charging” the trailer system. The trailer supply valve should be open when the tractor pressure has built up to approximately 90 psi, depending on the valve.

5

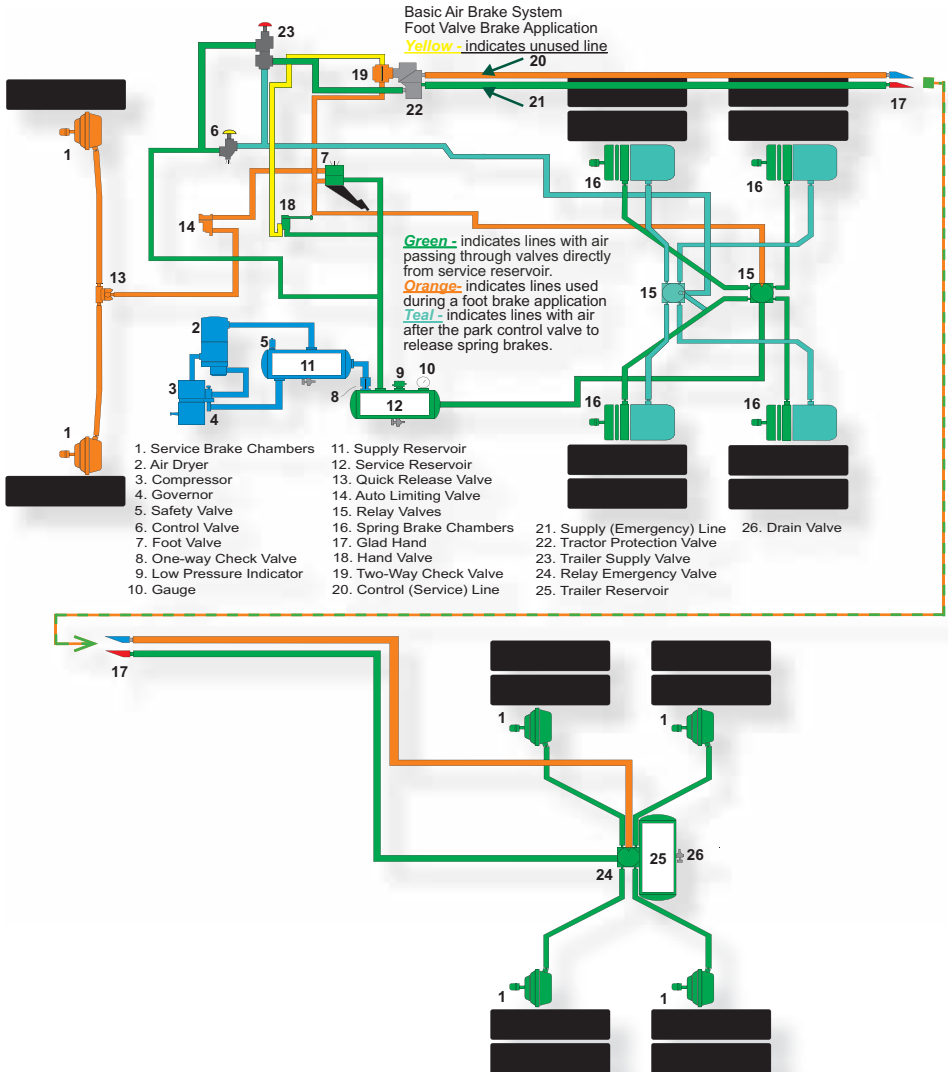

This illustration shows which brake components and lines are used for a foot valve application. Lines used after application

with the foot valve are in orange.

When the foot valve is depressed, the application air will be applied to the tractor brakes and the trailer brakes together. As previously explained, the two-way check valve has shifted, and application air is being directed through the tractor protection valve to the control (service) line. If the foot valve is released and the hand valve is applied, the shuttle in the two-way check valve would shift and application air would apply the trailer brakes only.

The next illustration shows which brake components and lines are used for a hand valve application. Lines used after a hand valve application are in brown. Application air directed from the hand valve causes control pressure to move through the control (service) line and act on the relay emergency valve. This control pressure will cause the relay emergency valve to direct air from the trailer reservoir to the trailer brake chambers. The pressure directed by the relay emergency valve to the trailer brake chambers will be the same as the pressure directed to the tractor brake chambers. In such a system, brake lag time has been minimized with the addition of the trailer reservoir and relay emergency valve.

Release of the hand valve stops the flow of application air. The relay portion of the valve returns to its original position, stopping the flow of air pressure. The exhausting ports of the valve exhaust the air pressure from the brake chambers, releasing the brakes. In this system, the brakes of both the tractor and trailer can be released quickly.

5

Caution: Trailer brakes must not be used to hold a parked vehicle that is left unattended. Loss of pressure will result in loss of brakes. Always set the parking brake.

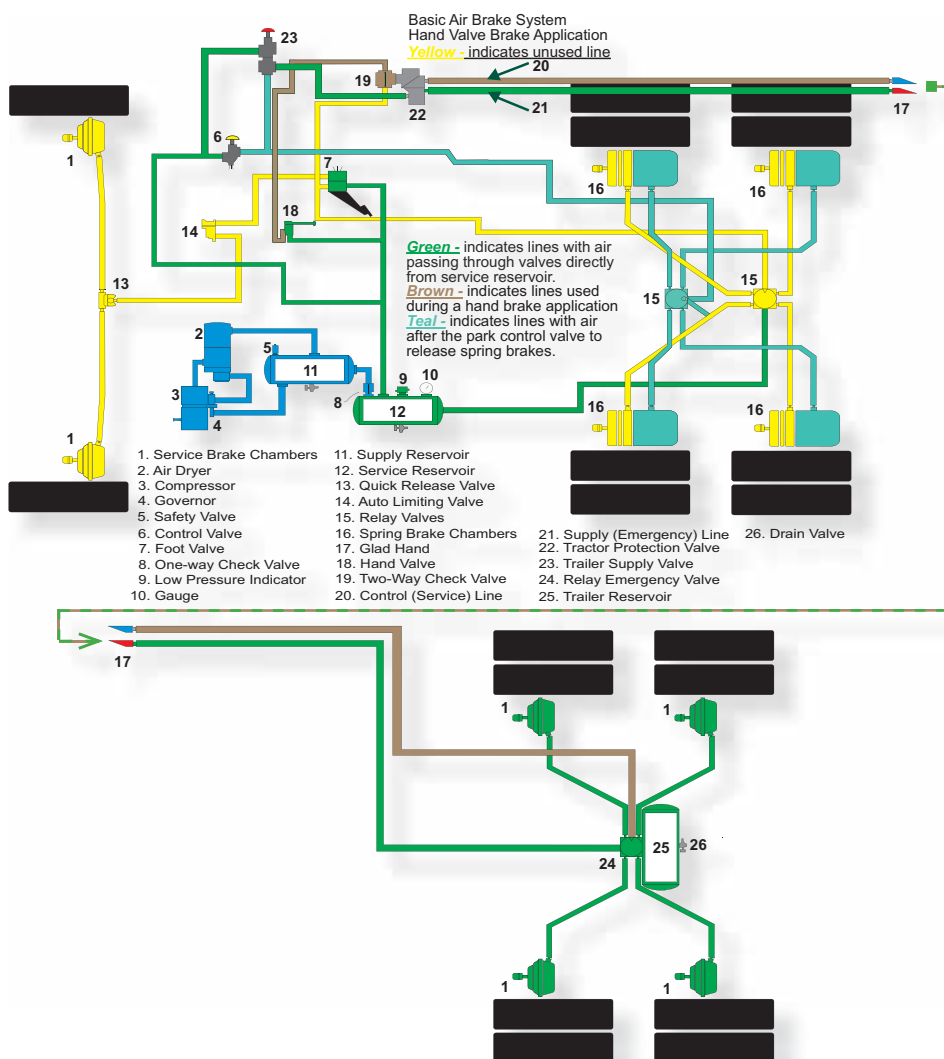

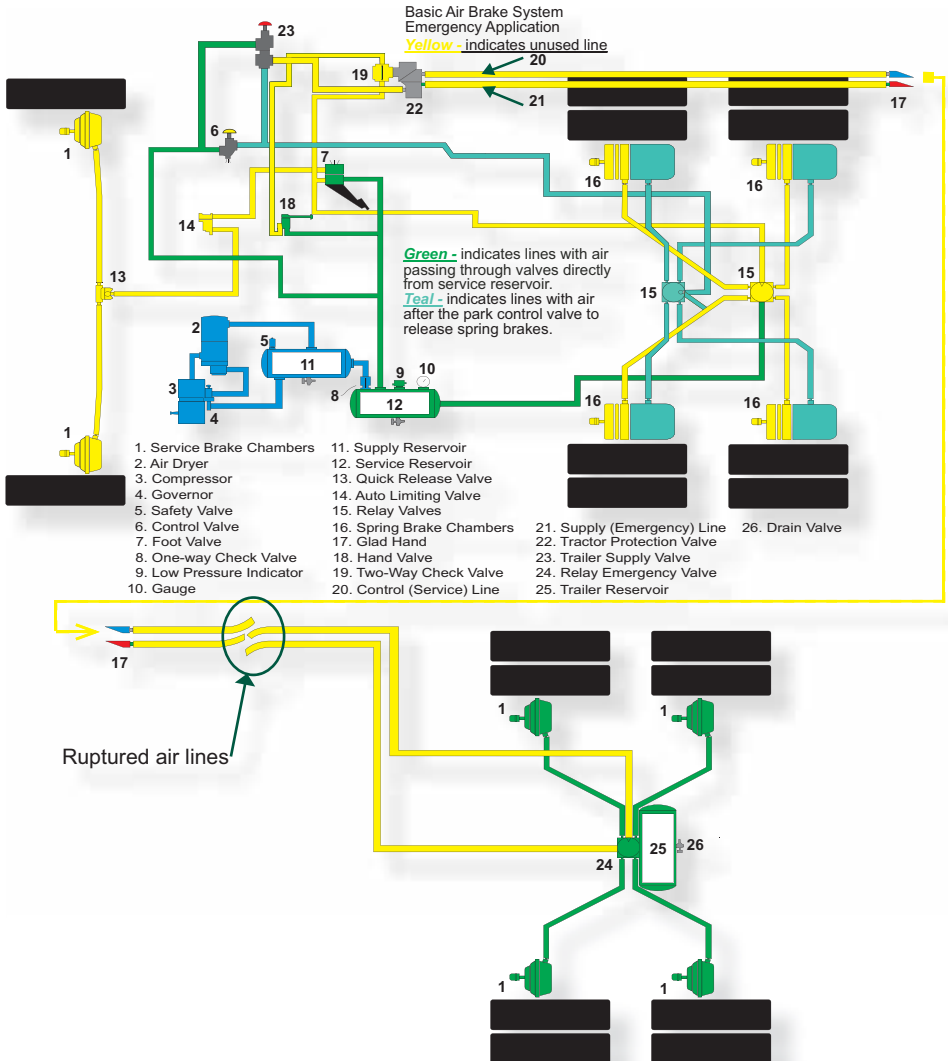

If a trailer that is not equipped with spring parking brakes were to separate from the tractor, the control (service) line (20) and the supply (emergency) line (21) would detach from the tractor.

5

The sudden loss of air pressure in the supply (emergency) line will trigger the relay emergency valve (24) which causes the trailer reservoir (25) to dump its air directly to the brake chambers (1) on the trailer. This places the trailer brakes into emergency application. The check valve in the relay emergency valve will close, preventing any bleed back of pressure from the trailer reservoir. The loss of pressure in the trailer supply (emergency) line will cause the tractor protection system to seal off the tractor leaving sufficient air pressure to brake the tractor.

The trailer brakes will remain applied until either the pressure in the trailer reservoir and lines is drained off, or the supply (emergency) line is repaired and the system is recharged.

A rupture of the supply (emergency) line (21) or an uncoupling of the supply (emergency) line glad hands will trigger the same action as described above. See following illustration.

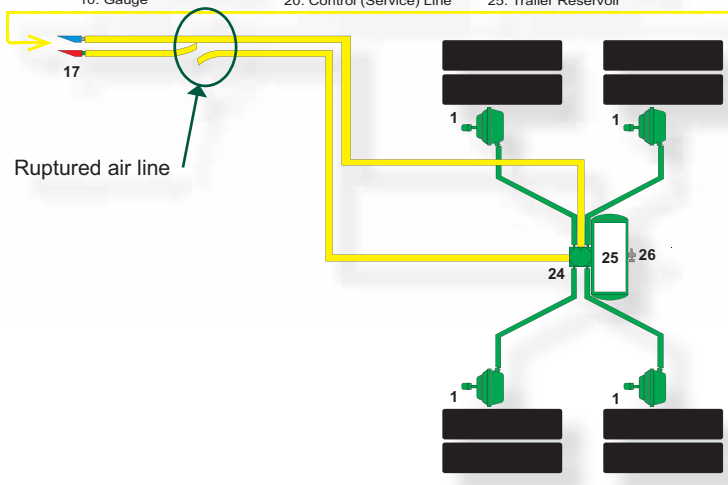
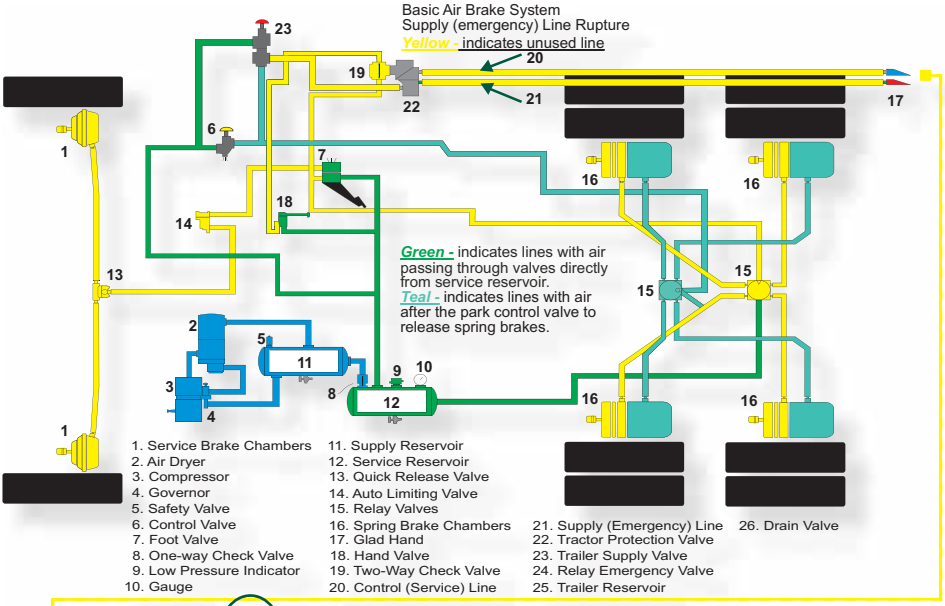

5

If the control (service) line (20) is ruptured or disconnected, no action will take place until a brake application is made. When it is made by either the foot or hand valve, the air loss from the control (service) line will lower the air pressure in the tractor's reservoirs quickly, depending on the amount of braking demanded. This air loss will eventually activate the tractor protection system which in turn will exhaust the trailer supply (emergency) line and cause the trailer relay emergency valve to apply the trailer brakes. It should be noted that any problem that causes a severe drop in reservoir pressure on the tractor system will cause the low warning device to signal the driver.

In the following illustration, the control (service) line (20) has ruptured and the driver is making a brake application with the foot valve (7). The tractor will have brakes applied but the trailer will have no brake action. If the brake application is held, the air pressure in the tractor system will lower to a dangerously low level and then the tractor protection system will place the trailer brakes into an emergency application.

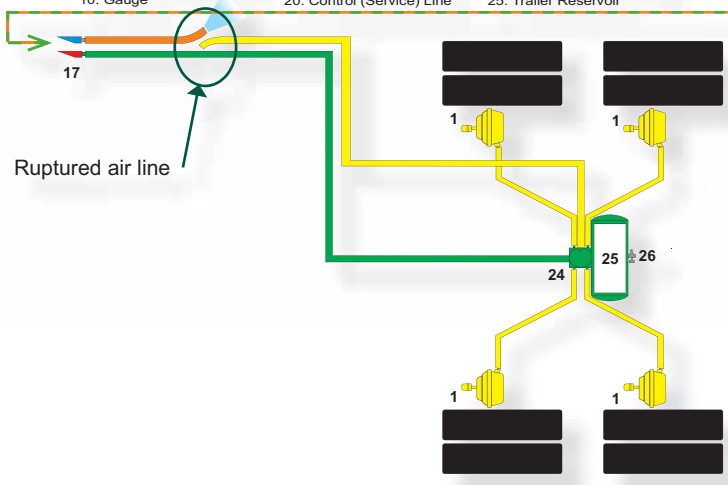
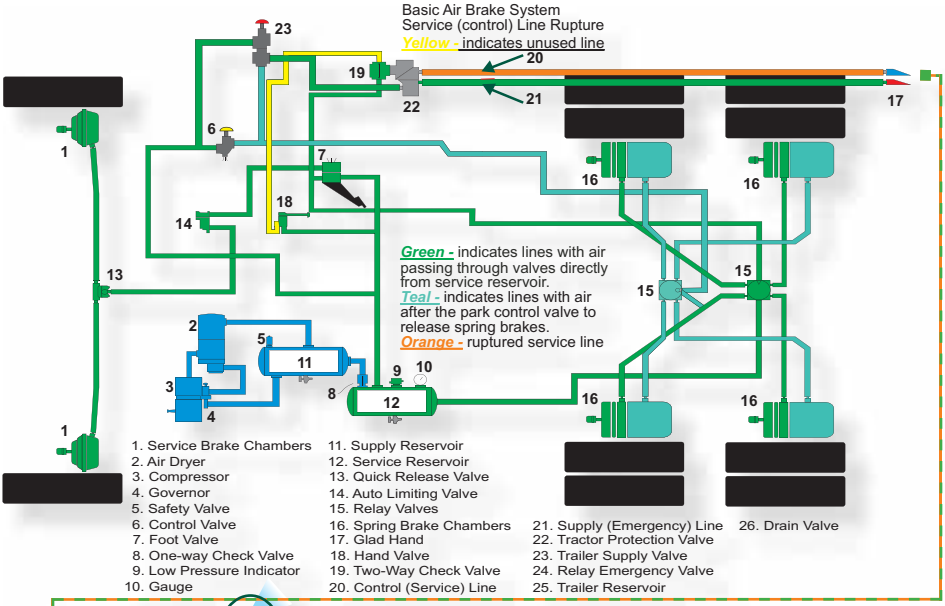

5

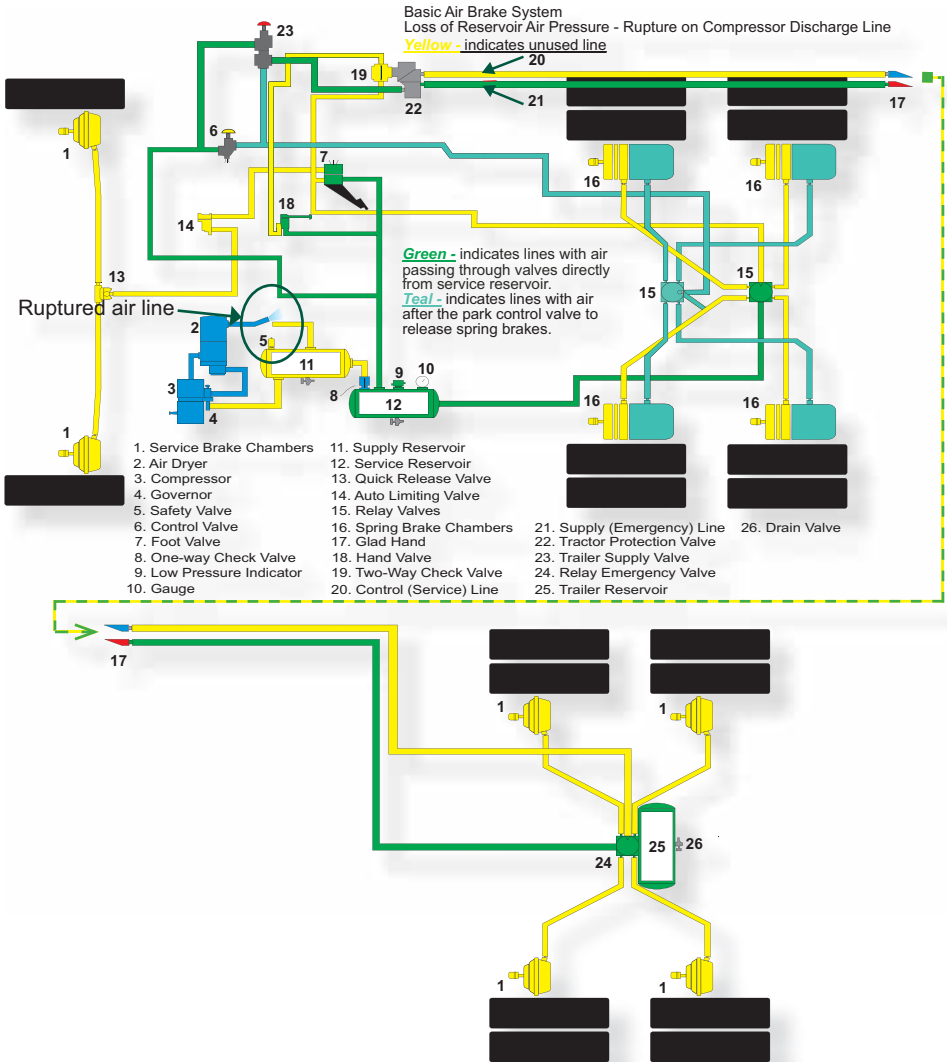

Rupture of the compressor discharge line would result in loss of air pressure from the supply reservoir. When the air pressure in the supply reservoir (11) of the tractor falls below the warning

level, due to a compressor failure or excessive leakage on the tractor, the warning devices will start to operate. In the diagram, the one-way check valve (8) has prevented the reservoir air pressure in the primary reservoir (12) from escaping back to the supply reservoir and the ruptured line. There is sufficient reservoir air pressure in the primary reservoir for a limited number of brake applications to stop the vehicle before the spring parking brakes are activated. (This will depend on how the spring parking brakes are piped in the system.)

In the next illustration the pressure has been lowered to approximately 45-20 psi and the tractor protection system has closed automatically, placing the trailer brakes into an emergency position. Also, the spring parking brakes system has had the air pressure released activating the spring parking brakes.

The truck protection system described is an example of a tractor equipped with a type of cab-mounted trailer supply valve (23) which will close automatically when the air pressure in the supply (emergency) line (21) drops below 45-20 psi. The valve may also be closed manually.

5

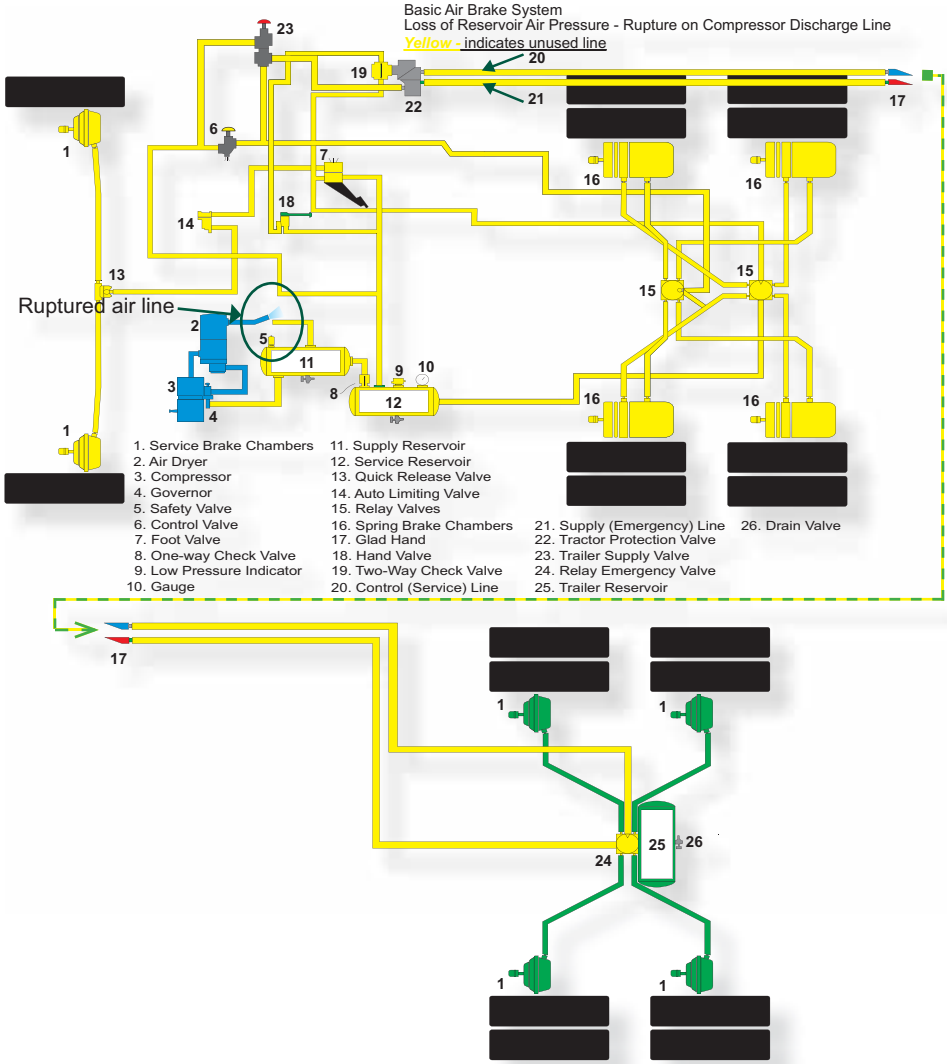

Manual Trailer Supply Valve

Some older tractors may be equipped with a different type of cab-mounted trailer supply valve which must be operated manually by the driver. It has two positions: normal and emergency.

The tractor will be equipped with a tractor protection valve, and the trailer unit with a relay emergency valve, as in the previous system.

The functions of the trailer supply valve, tractor protection valve and the relay emergency valve will be similar to those explained previously. However, there is one important difference. In the event of tractor reservoir air loss, the trailer supply valve must be shifted to the emergency position manually to seal off the tractor.

Any time the driver shifts the cab-mounted trailer supply valve to the emergency position, and the trailer system is charged, the trailer supply valve will exhaust the supply (emergency) line, which causes the trailer reservoir to dump its air directly to the trailer brake chambers.

The trailer brakes will remain applied only as long as air pressure remains within the trailer system. How long the air in the system will hold the brakes applied depends on how airtight the system is. As a safety precaution, parked trailers without spring parking brakes should always have the wheels blocked to prevent a possible runaway. To move a trailer that has been parked with the brakes in an emergency application, it is necessary to charge the system to release the trailer brakes.

Trailer Spring Parking Brakes

Spring parking brakes are now commonly found on trailers. Spring parking brakes serve as a means of securing a parked trailer whether it is attached to a tractor or not. The spring parking brakes are applied with spring pressure and not air pressure, so there is no risk of the parking brakes releasing and the trailer moving. They also act as an emergency braking system if the trailer were to break away from the tractor or if the tractor lost adequate air pressure.

A trailer with spring parking brakes has these components:

- front (27) and rear (28) service reservoirs
- trailer spring parking brake valve (29)
- relay valve (15) (the same as on a tractor - not an emergency relay valve used on trailers without spring parking brakes)
- spring parking brake chambers (16) (same as on a tractor)

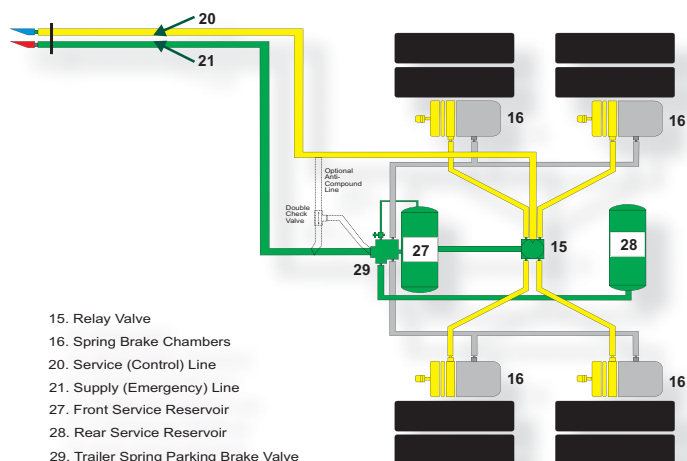

The trailer spring parking brake valve is responsible for several important functions:

- It controls the application and release of the trailer's spring brakes.
- It protects and isolates the front service reservoir from the rear service reservoir. This is important as it prevents an automatic application of the trailer spring brakes if one of the reservoirs were to lose air pressure.
- It prevents automatic spring brake application if the trailer supply line has a gradual leak.
- It will automatically apply the spring parking brakes if supply pressure is rapidly lost (ie: trailer breakaway).

Chapter 6

NWT Air Brake Manual

Dual Air Brake System



Dual Air Brake System

More and more heavy duty vehicles on the road today are using a dual air brake system. The system has been developed to accommodate a mechanically secured parking brake that can be applied in the event of service brake failure. It also accommodates the need for a modulated braking system should either one of the two systems fail. It is actually two brake systems in one, with more reservoir capacity resulting in a much safer system. At first glance, the dual system might seem complicated, but if you understand the basic air brake system described so far, and if the dual system is separated into basic functions, it becomes quite simple.

As its name suggests, the dual system is two systems or circuits in one. There are different ways of separating the two parts of the system. On a two-axle vehicle, one circuit operates the rear axle and the other circuit operates the front axle. If one circuit has a failure, the other circuit is isolated and will continue to operate.

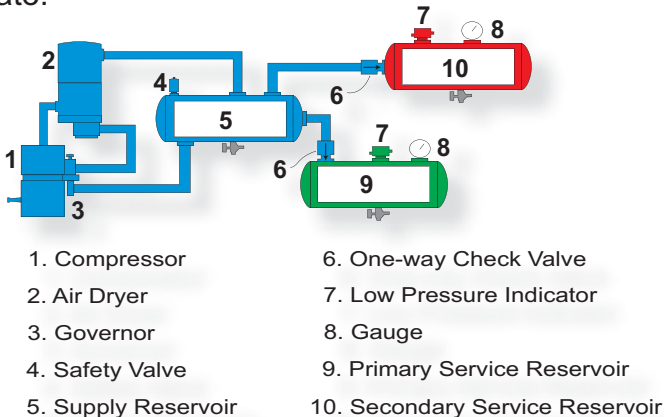

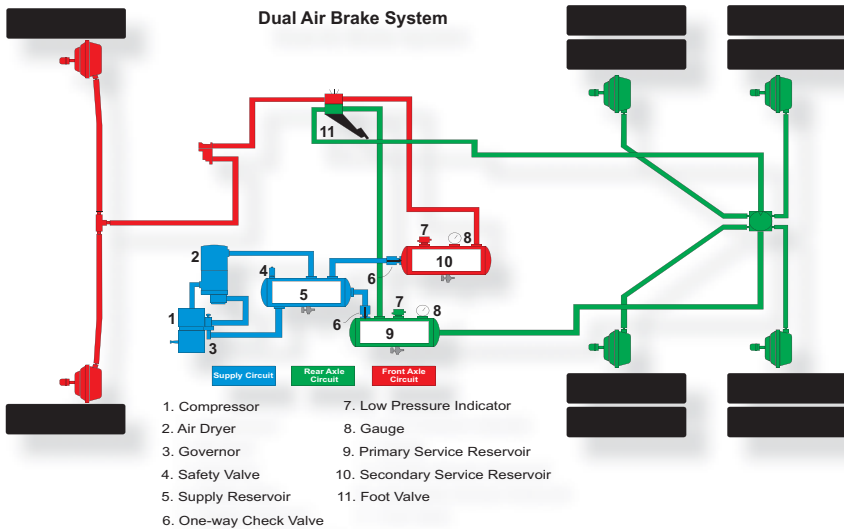

In the illustration, air is pumped by the compressor (1) to the supply reservoir (5) (blue), which is protected from over pressurization by a safety valve (4). Pressurized air moves from the supply reservoir to the primary reservoir (9) (green) and the secondary reservoir (10) (red) through one-way check valves (6). At this point, the dual circuits start. Air from the primary reservoir is directed to the foot valve (11). Air is also directed from the secondary reservoir to the foot valve. The foot valve is similar to the one described earlier in the basic air brake system, but is divided into two sections (two foot valves in one). One section of this dual foot valve controls the primary circuit and the other controls the secondary circuit. When a brake application is made, air is drawn from the primary reservoir through the foot valve and is passed on to the rear brake chambers. At the same time, air is also drawn from the secondary reservoir, passes through the foot valve and is

6

passed on to the front brake chambers. If there is air loss in either circuit, the other will continue to operate independently. Unless air is lost in both circuits, the vehicle will continue to have braking ability. The primary and secondary circuits are equipped with low air pressure warning devices, which are triggered by the low air pressure indicator switch (7) and reservoir air pressure gauges (8) located on the dash of the vehicle.

Dual Circuit Foot Valve

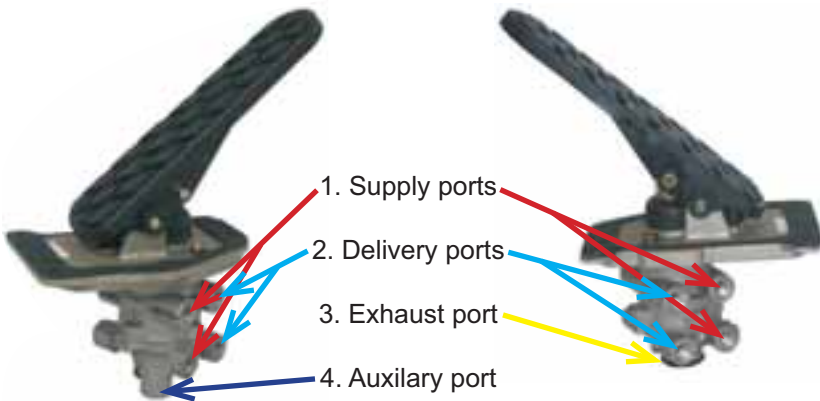

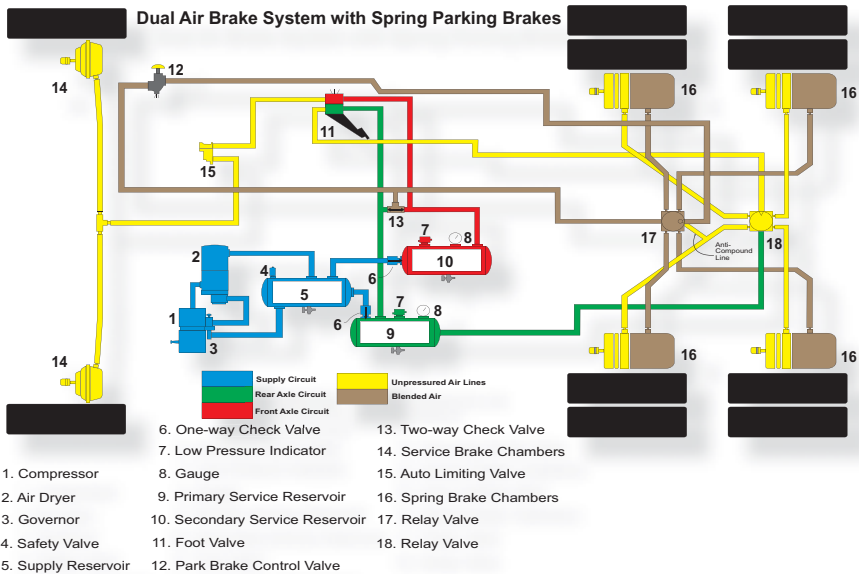

When spring brakes are added to a dual air brake system, the same type of dash control valve discussed previously is used. Blended air is used to supply the spring parking brake control valve (12). Blended air is air taken from the primary and secondary circuits through a two-way check valve (13). With this piping arrangement the vehicle can have a failure in either circuit without the spring brakes applying automatically. If air is lost in both circuits, the spring brakes will apply.

6

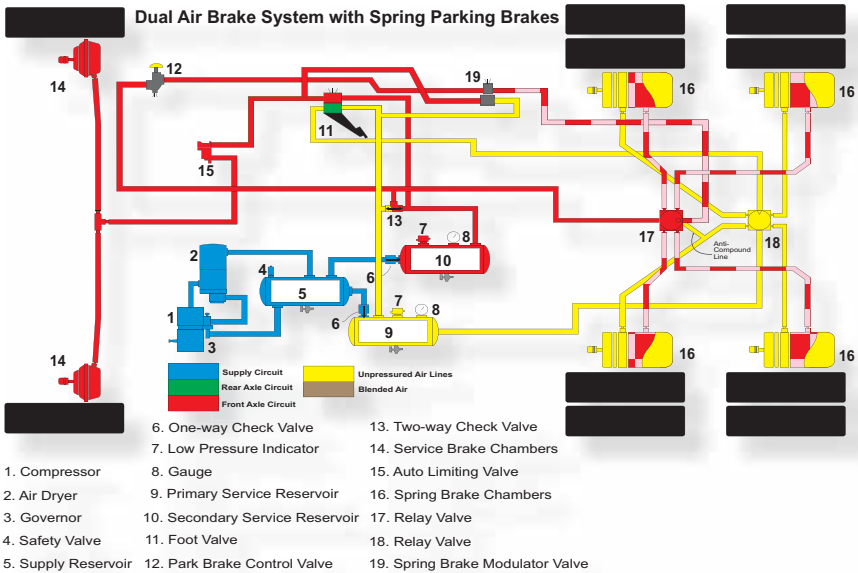

Spring parking brakes in this system serve two purposes: first, as a parking brake, and second as an emergency braking system. If a failure occurs in the primary circuit (green), and a brake application is made, control air from the foot valve is directed to a spring brake modulator valve (19). As there is no supply air to maintain balance in the modulator valve, because of the primary circuit failure, the modulator valve then exhausts air pressure from the spring parking brake circuit. The amount of air released is equal to the amount of air applied by the foot valve. The release of air in the spring parking brake circuit causes the drive axle to brake using spring pressure (16). When the brakes are released, supply air from the secondary circuit (red) returns the spring parking brakes to an off position. Brake applications can be repeated until all the air from the secondary circuit is lost. However as the air pressure drops below 85 psi,

the spring parking brakes won't return to the full off position. In fact, they will start to drag. At approximately 35 psi, the parking brake control valve (12) on the dash will exhaust the remaining air in the secondary circuit, and the spring parking brakes are fully applied. The only way the vehicle can be moved after all air is lost is to repair the damaged circuit and recharge the system, or cage the spring parking brake system.

Combination Tractor and Trailer with Spring Parking Brakes

The trailer system is supplied by blended tractor air taken from the primary and secondary circuits through a two-way check valve as previously described.

The system is charged by opening the trailer supply valve (21), allowing air from the tractor to pass through the tractor protection valve (23) and the trailer spring parking brake valve (19) directly into the trailer spring parking brake chambers (16). When air enters, the pressure protection part of the trailer spring parking brake valve opens, allowing the air to fill the trailer reservoirs. The trailer spring brakes will not release until the reservoir pressure on the trailer is adequate.

When a brake application is made, blended control air acts on the relay valve (30), which releases air from the trailer reservoir to the brake chambers.

In a dual air brake system, if one circuit develops a leak, the other circuit would be protected from air pressure loss by the two-way check valve (13) that is circled in the next diagram.

6

If the tractor breaks away from the trailer, the control (service) and supply (emergency) lines will be pulled apart. The sudden loss of air in the supply (emergency) line will cause the tractor protection valve to close, preventing air from escaping out of either broken connection. The air supply in the tractor is sealed off and is available to control the tractor brakes. At the same instant, the sudden loss of air in the supply (emergency) line causes the trailer spring parking brake valve to exhaust the air from the trailer spring parking brake chambers, applying the trailer brakes. The trailer brakes cannot be released under these conditions unless the lines are recoupled and the trailer reservoirs recharged.

If only the supply (emergency) line breaks between tractor and trailer, the same sequence of events will occur.

A break or rupture in the control (service) line will not affect the trailer until a brake application is made. A loss of pressure in the tractor system will then result, causing the same emergency brake application described above. However, the driver will be able to release the spring parking brakes by releasing the foot valve, rebuilding air pressure and opening the trailer supply valve.

To apply the spring parking brakes, the spring parking brake control valve (12) is closed, causing a loss of air pressure in the line which applies the spring parking brakes as described above.

The old and new tractor and trailer systems are fully interchangeable, whether they are a dual air brake system or

basic air brake system, and whether they are systems with or without spring parking brakes.

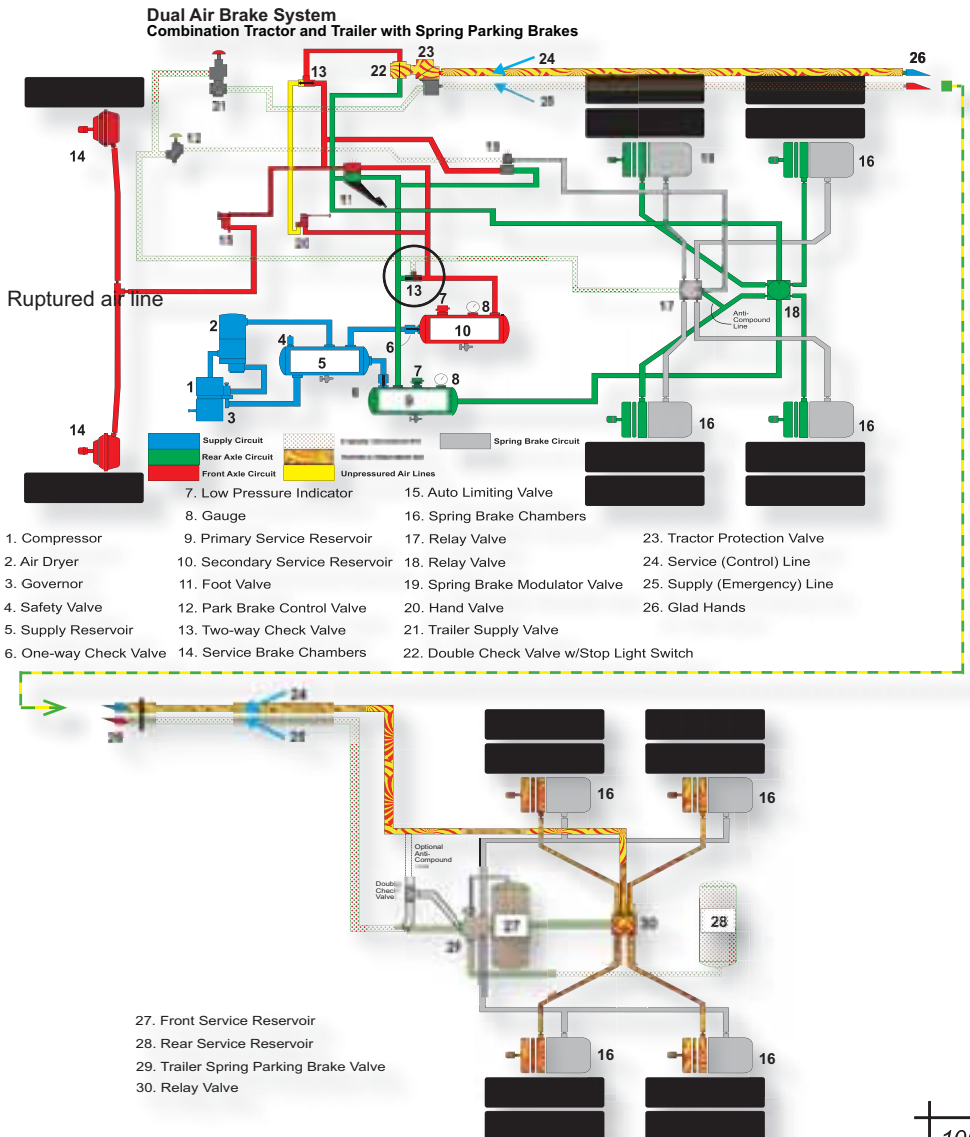



Chapter 7

NWT Air Brake Manual

Brake Adjustment and In-Service Check

7

Brake Adjustment

On vehicles equipped with hydraulic brakes it is possible to pump the brake pedal to compensate for brakes that are out of adjustment. This is not possible with a vehicle equipped with an air brake system with manual slack adjusters. When the brakes are adjusted by slack adjusters, the shoes are moved outwards. This brings them as close to the drums as possible minimizing the amount of free travel when the brakes are applied. It also reduces the volume of air used to apply the brakes.

Brake adjustment (push rod travel) must be checked as part of the pre-trip air brake inspection (Section 8).

S-cam Brake

The following are recommended steps to determine if an S-cam brake with manual or automatic slack adjusters requires adjustment.

- Ensure vehicle is secure and wheels are blocked.
- Shut off the engine, leaving the transmission in a low gear or park then release the spring parking brakes.
- Make a chalk mark where each push rod enters the brake chamber.
- Re-apply the spring parking brakes and measure the distance from the brake chamber to the chalk mark. Ensure the slack (push rod travel) is within 3/4 and 1 1/2 inches or within manufacturer's specifications and the angle between the slack adjuster and push rod is 90° or as close as practical. If not, then a brake adjustment is required.

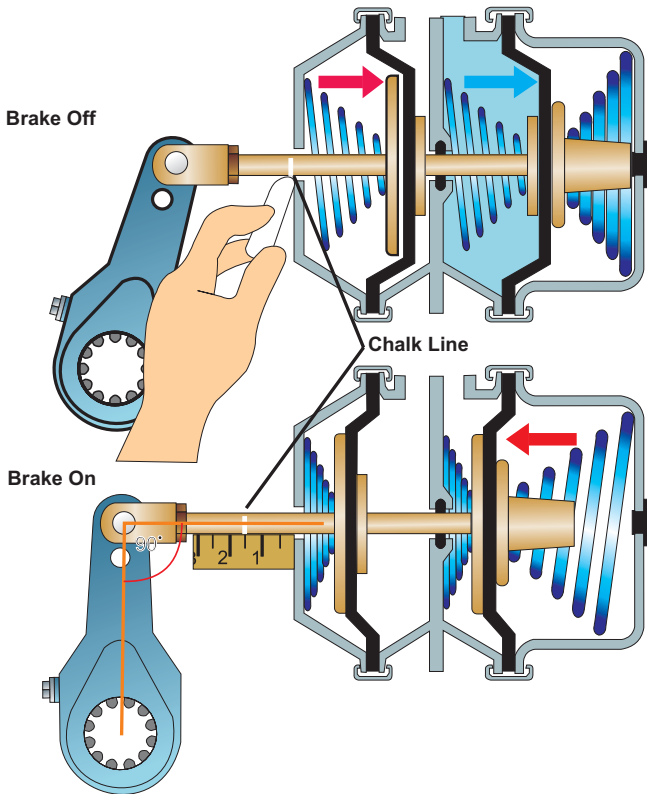

When the brakes are out of adjustment, braking efficiency is reduced by three factors:

1. Brake lag increases because additional air is required to fill and pressurize the increased chamber volume caused by the increased stroke of the push rod.
2. The angle between the slack adjuster arm and the push rod becomes more than 90° , which results in a loss of force between the linings and the drum.
3. The effectiveness of diaphragm brake chambers drops off significantly if the stroke exceeds 75% of its designed

7

travel. For a type 30 chamber (30 square inches of effective diaphragm area) that has a design stroke of 2 1/2 inches, the brakes should be adjusted at or before 1 1/2 inches of travel. With a working pressure of 100 psi this chamber will produce a force of 3,000 lb at 1 1/2 inches of travel, but only 2,500 lb of force at a travel of 2 1/4 inches. Remember, when a chamber bottoms out, the force reduces to zero.

Other factors that affect the braking ability of the vehicle include:

- overheated brakes;
- worn linings;
- oversize drums;
- malfunctioning valves;
- valves with above normal release pressure;
- seized or partially seized brake camshafts or shoe anchors;
- excessive moisture in reservoirs;
- contaminated brake linings.

Stroke vs. Force

The amount of force available at the push rod is consistent out to two inches of stroke. After two inches, push-rod force drops very quickly.

Don't be Fooled - Check the Slack

It is up to you, the driver, to ensure that your vehicle has safe, properly adjusted brakes. If the brakes are not working properly even with sufficient air pressure you should stop, check brakes and adjust as necessary.

Brake failures are seldom the result of a major system failure. They are usually the result of brakes being out of adjustment, often to the point that there is no braking action on some wheels.

Under frequent braking conditions and depending on the severity, there will be some expansion of the brake drum because of heat and the amount will vary with the thickness of the drum. This expansion of the drum will also add to the overall push rod travel.

The driver must be trained in brake adjustment prior to attempting the practical examination. You will be expected to be able to make a brake adjustment.

S-cam Brake Adjustment with Manual Slack Adjuster

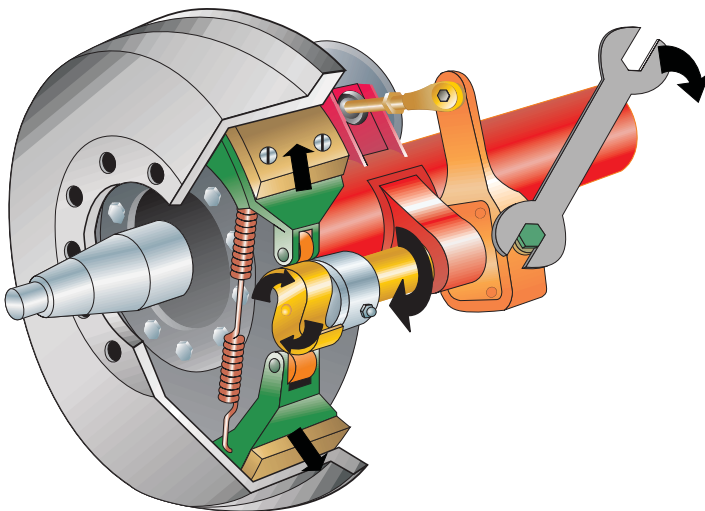

7

- Ensure vehicle is secure and wheels blocked, release the parking brake.
- Verify system is at full pressure.
- Use a proper wrench to disengage the external locking device (if so equipped) from the adjustment bolt of the slack adjuster.
- Turn the adjustment bolt (1) until the lining contacts the drum and the adjustment bolt will not turn any further. If possible, visually check to see that the brake linings are in contact with the brake drum (2). Pull or pry on the slack adjuster (3). There should be no movement or free play. If there is free play, you have turned the adjusting nut the wrong way.

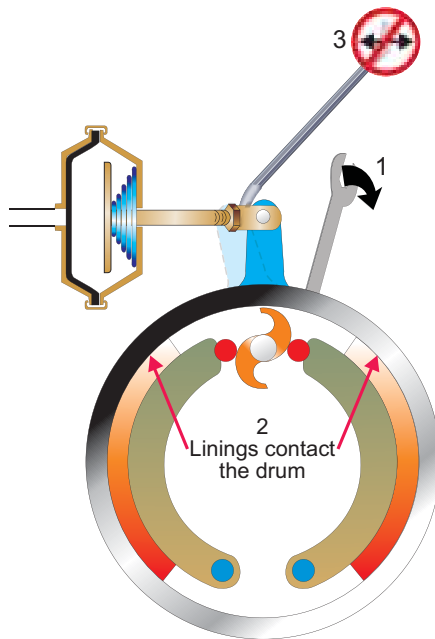

- When turning the adjustment bolt on the slack adjuster, **the S-cam should turn in the same direction as if a brake**

application were being made.

- Back off the adjustment bolt about 1/4 to 1/2 (4) of a turn and ensure the locking device re-engages.
- Now recheck slack adjuster travel. The travel should now be between 1/2 to 3/4 inches free travel while pulling on the linkage by hand or using a pry bar (5), or within manufacturer's specifications.

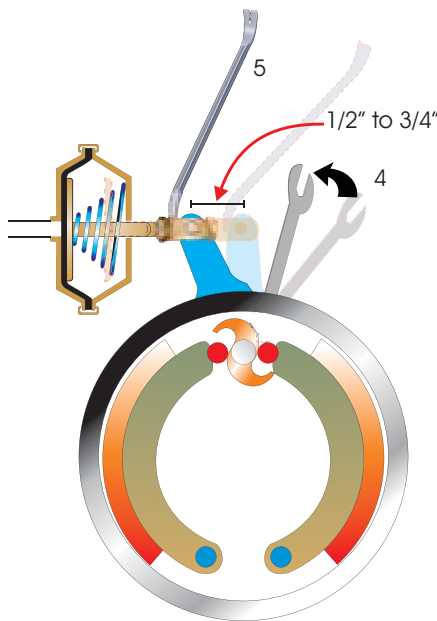

Note: Applicants conducting an air brake examination will be required to satisfactorily adjust S-cam brakes with manual slack adjusters.

The equipment required to adjust a brake must be supplied by the applicant.

7

S-cam Brake with Automatic Slack Adjuster

Automatic slack adjusters adjust themselves during brake applications to accommodate for brake lining and drum wear. However, they must be checked daily to ensure they are maintaining proper push rod travel when the brake is applied. Normally two to four brake applications of 80-100 psi per day will keep the brakes properly adjusted. A driver may be required to consciously make these applications when starting out for the day or during the trip when possible. If they are badly out of adjustment, a qualified individual should inspect them. Adjusting automatic slack adjusters by hand is not recommended unless you are thoroughly trained on the proper adjustment procedures as dictated by the manufacturer. If an automatic slack adjuster requires adjusting by hand the slack adjuster may not be working properly and should be inspected or replaced by a trained and qualified person as soon as possible.

Disc Brake Adjustment

There are a number of makes and models of air disc brakes, each with a different adjustment procedure. It is therefore recommended that you consult the manufacturer's manual for adjustment or service.

Wedge Brake Adjustment

Manual adjusters:

- Hoist or jack wheels off the ground.
- Remove dust cover from adjusting slots at two places on each brake. On twin chamber units the adjusting slots are in the backing plate below the forward chamber and above the

rear chamber. If star wheel adjusting bolts are not found at these positions, the brake has been assembled on the wrong side of the vehicle. The single chamber units have adjusting slots in the backing plate on each side of the chamber.

- Adjusting bolts have right-hand threads. Turning the wheel by hand, use an adjusting spoon to turn the star wheel until the shoe develops a heavy drag on the drum. Then back off the bolt to a very light drag on the drum.
- Repeat for the other shoe on that brake assembly.
- Replace the dust covers in the adjusting slots.
- Repeat the above steps on the other brake assemblies.

After a Brake Adjustment

At the first stop after adjusting the brakes, check each brake drum or rotor for temperature. An extra hot brake drum indicates that you have overadjusted it.

Only when all brakes are properly adjusted will the system be able to absorb the required amount of energy to bring the loaded vehicle to a safe stop under extreme conditions. Remember that poorly adjusted air brakes may appear to be working at slow speeds on light air application. The only way to be sure your vehicle brakes are properly adjusted is to physically check the brakes at each wheel.

TRUCKS

**STOP HERE
CHECK BRAKES
STEEP HILL
AHEAD**

In-service Checks

In some areas signs are posted in advance of steep or long downgrades. These signs indicate that the driver must stop the vehicle in the pullout area and inspect the braking system before proceeding. Check that:

- the compressor is maintaining full reservoir air pressure;
- push rod travel is within limitations on all chambers;
- there are no air leaks;
- the glad hands and the lines are secure;
- the drums, bearings and tires are not overheating;
- the trailer supply valve is operating properly.

This should be used as an in-service check only and not mistaken as a daily pre-trip air brake inspection.

The driver must be aware of the condition of the vehicle's braking system at all times. This can be done by:

- watching the pressure gauges;
- hearing the warning signals; and
- feeling the braking response of the vehicle.

By these methods of observation, the driver should be able to notice any defects developing in the braking system and be aware that service or adjustment is required.

Maintenance and Servicing of the Air Brake System

Ensuring that the vehicle is in proper condition to drive is the responsibility of everyone involved.

Preventive maintenance checks are designed to prevent mechanical failures that could result from neglect. These checks cut repair costs by detecting minor mechanical defects which would otherwise develop into major breakdowns.

Remember, if one set of brake shoes is poorly adjusted, the remaining sets of brake shoes must increase their braking effort and may become overheated.

Preventive maintenance may be assigned to a maintenance crew or to the driver. However the driver must ensure that the braking system is in operating condition before the vehicle moves.



Chapter 8

NWT Air Brake Manual
Pre-Trip Air Brake
Inspection

8

Pre-Trip Air Brake Inspection

Single Unit (not for air over hydraulic systems)

When upgrading your driver's licence from single to combination vehicles with air brakes, you will be required to satisfactorily demonstrate the complete pre-trip air brake inspection for combination vehicles.

The pre-trip air brake inspection should be completed within 20 minutes. Failure to complete the test within 20 minutes may result in the test being discontinued.

Practical examination will be conducted in either the Metric or Imperial systems of measurement, whichever coincides with the equipment being operated.

Vehicle Secure

- Set the spring parking brake on the vehicle.
- Block the wheels; the vehicle should be on level ground if possible.
- Check that the compressor is secure.
- Check the drive belt and pulleys for wear, cracking, slippage and tension (if equipped).
- Drain all reservoirs completely (supply reservoir first). When reservoirs are empty close the drain valves. For testing purposes only, the applicant will not be required to manually drain the reservoirs. Instead, the applicant may verbally explain the steps that they must follow when draining the reservoirs and then fan the brake pedal to empty the reservoir.

- Check brake chambers, air lines and slack adjusters for security and wear.

NOTE: Reservoirs must be drained at least daily to ensure the removal of all moisture and contamination that if left in the system can lead to system and component failures.

NOTE: When draining the air reservoirs, be sure to open the drain cocks fully, draining from maximum system pressure to zero pressure. This will maximize the release of contamination. Always drain the supply reservoir prior to draining service reservoirs.

Compressor and Warning Devices Check

- Start the engine and run at fast idle to build air pressure.
- Warning device(s) must operate to 55 psi or higher.
- Ensure reservoir air pressure builds from 50 to 90 psi within three minutes.
- Release the spring parking brake at 90 psi or above to prevent compounding the brake pressure.
- Continue building reservoir air pressure. Check that the governor places the compressor in the unloading stage between 115 psi minimum and 135 psi maximum.
- Fan the brake pedal until the pressure drops to 80 psi; stop fanning to see if the governor has placed the compressor in the loading stage (the reading on the air pressure gauge should increase).
- Continue fanning the brake pedal. Warning device(s) must operate at or before 55 psi and the spring parking brake should apply at or before the reservoir pressure drops to 20 psi.

Check for Leakage

- Rebuild reservoir air pressure at fast idle to between 115 psi minimum and 135 psi maximum, release the spring parking brake at 90 psi.
- Shut off the engine.
- Make a full brake application with the foot valve and hold. Observe the reservoir air pressure gauge.
- The reading should not drop more than 4 psi per minute. Lightly tap the gauge to ensure it is not sticking. For an accurate reading brake application should be held for at least two minutes.
- Listen for audible air leaks.
- Release full brake application.

Brake Adjustment

(A driver should be trained in brake adjustment prior to attempting practical examination and supply the equipment required to do a brake adjustment.)

The following are recommended steps to determine if an S-cam brake with manual slack adjusters requires adjustment.

- Ensure vehicle is secure and wheels are blocked. Verify the system is at full pressure.
- Shut off the engine. Leaving the transmission in a low gear or park.
- Release the spring parking brakes.
- Make a chalk mark where the push rods enter the brake chambers.
- Re-apply spring parking brakes and measure the distance

from the brake chamber to the chalk mark. Ensure the slack (push rod travel) is within $3/4$ to $1-1/2$ inches or within manufacturer's specifications and the angle between the slack adjuster and push rod is 90° or as close as practical. If not, then a brake adjustment is required.

The following are recommended adjustment steps for S-cam brakes with manual slack adjusters.

- Ensure vehicle is secure and wheels blocked, release the spring parking brake.
- Verify reservoirs are at full pressure.
- Use a wrench to disengage the external locking device (if so equipped) from the adjustment bolt of the slack adjuster.
- Turn the adjustment bolt until the brake lining contacts the brake drum. If possible, visually check to see that the brake linings are in contact with the brake drum.
- When turning the adjustment bolt on the slack adjuster, **the S-cam should turn in the same direction as if a brake application were being made.**
- Back off the adjustment bolt about $1/4$ to $1/2$ of a turn. Check that the push rod free travel is now between $1/2$ to $3/4$ inches when using pry bar or hand, or within manufacturer's specifications.

Brake Test

- Re-apply the spring parking brake, remove wheel blocks.
- Gently tug against the spring parking brakes in low gear. It should hold the vehicle.
- Release the spring parking brakes.
- Move vehicle ahead slowly and make a service brake

8

application to check brake response.

Combination Unit

When upgrading your driver's licence from single to combination vehicles with air brakes, you will be required to satisfactorily demonstrate the pre-trip air brake inspection for combination vehicles.

The pre-trip air brake inspection should be completed within 30 minutes. Failure to complete the test within 30 minutes may result in the test being discontinued.

Practical examination will be conducted in either the Metric or Imperial systems of measurement, whichever coincides with the equipment being operated.

Vehicle Secure

- Set the spring parking brake on tractor and trailer.
- Block the wheels; the vehicle should be on level ground if possible.
- Check that the compressor is secure.
- Check the drive belt and pulleys for wear, cracking, slippage and tension (if equipped).
- Drain all reservoirs completely (supply reservoir first). When reservoirs are empty close the drain valves. "For testing purposes only, the applicant will not be required to manually drain the reservoirs. Instead, the applicant may verbally explain the steps that they must follow when draining the reservoirs and then fan the brake pedal to empty the reservoir."
- Check brake chambers, air lines and slack adjusters for

security and wear.

- Ensure the air brake glad hands and trailer electrical cord are connected properly.

NOTE: Reservoirs must be drained at least daily to ensure the removal of all moisture and contamination that if left in the system can lead to system and component failures.

NOTE: When draining the air reservoirs, be sure to open the drain cocks fully, draining from maximum system pressure to zero pressure. This will maximize the release of contamination. Always drain the supply reservoir prior to draining service reservoirs.

Compressor and Warning Devices Check

- Start the engine and run at fast idle to build air pressure.
- Warning device(s) must operate to 55 psi or higher.
- Ensure reservoir air pressure builds from 50 to 90 psi within three minutes.
- At 90 psi or above, release the spring parking brakes to prevent compounding the brake pressure and charge the trailer system by opening the trailer supply valve. Apply and release the trailer brakes to ensure they are releasing. (Failure to release could indicate supply (emergency) and control (service) lines are crossed).
- Continue building reservoir air pressure. Check that the governor places the compressor in the unloading stage between 115 psi minimum and 135 psi maximum.
- Fan the brake pedal until the pressure drops to 80 psi; stop

fanning to see if the governor has placed the compressor in the loading stage (the reading on the air pressure gauge should increase).

- Continue fanning the brake pedal. Warning device(s) must operate at or before 55 psi and the trailer supply valve will close at or before 20 psi. Continue fanning the brake pedal. The spring parking brake should also apply at or before the reservoir pressure drops to 20 psi.
- Rebuild reservoir air pressure at fast idle to between 115 psi minimum and 135 psi maximum. At 90 psi charge the trailer system by opening the trailer supply valve.
- Set the tractor spring parking brake (if possible).

Tractor Trailer Emergency System Check

- Disconnect supply (emergency) line glad hand.
- Trailer brakes should apply immediately.
- There should be no air loss from trailer glad hand.
- Air from the tractor should:

(a) stop immediately or,

(b) bleed down no lower than 20 psi and stop.

Note: Under no circumstances should the tractor pressure drain below 20 psi.

- Reconnect supply (emergency) line and charge trailer. Rebuild pressure if necessary.

Tractor Protection Valve Check

- Disconnect control (service) line glad hand.
- No air should escape from the tractor or trailer glad hands.
- Release the spring parking brake.
- Make full brake application. Tractor brakes will function

normally. Trailer service brakes will not function at all. With brake application maintained, air will continue to escape from the control (service) line until air pressure in the reservoirs is depleted to no lower than 20 psi. The trailer supply and the tractor protection valve will close and the tractor and trailer brakes will apply. Air loss from control (service) line will stop.

- Reconnect control (service) line.

Check for Leakage

- Rebuild reservoir air pressure at fast idle to between 115 psi minimum and 135 psi maximum, release the spring parking brake and charge the trailer at 90 psi.
- Shut off the engine.
- Make a full brake application with the foot valve and hold. Observe the reservoir air pressure gauge.
- The reading should not drop more than 4 psi (6 psi with two trailers) per minute. Lightly tap the gauge to ensure it is not sticking. For an accurate reading brake application should be held for at least two minutes.
- Listen for audible air leaks.
- Release full brake application.

Brake Adjustment

(A driver should be trained in brake adjustment prior to attempting practical examination and supply the equipment required to do a brake adjustment.)

The following are recommended steps to determine if an S-cam brake with manual slack adjusters requires adjustment.

8

- Ensure vehicle is secure and wheels are blocked.
- Verify the system is at full pressure.
- Shut off the engine. Leaving the transmission in a low gear or park.
- Release the spring parking brakes.
- Make a chalk mark where the push rods enter the brake chambers, repeat this on all the brake chambers.
- Re-apply spring parking brakes and measure the distance from the brake chamber to the chalk mark. Ensure the slack (push rod travel) is within 3/4 to 1-1/2 inches or within manufacturer's specifications and the angle between the slack adjuster and push rod is 90° or as close as practical. If not, then a brake adjustment is required.

The following are recommended adjustment steps for S-cam brakes with manual slack adjusters.

- Ensure the vehicle is secure and the wheels are blocked.
- Release the spring parking brakes.
- Verify reservoirs are at full pressure.
- Use a wrench to disengage the external locking device (if so equipped) from the adjustment bolt of the slack adjuster.
- Turn the adjustment bolt until the brake lining contacts the brake drum. If possible, visually check to see that the brake linings are in contact with the brake drum.
- When turning the adjustment bolt on the slack adjuster, **the S-cam should turn in the same direction as if a brake application were being made.**
- Back off the adjustment bolt about 1/4 to 1/2 of a turn.
- Now recheck slack adjuster travel. Check that the push rod free travel is now between 1/2 to 3/4 inches when using a

pry bar or hand, or within manufacturer's specifications.

Brake Test

- Re-apply the spring parking brake, remove wheel blocks.
- Gently tug against the spring parking brakes in low gear, it should hold the vehicle.
- Release the spring parking brakes and set trailer brakes with the hand valve.
- Gently tug against trailer brakes in low gear.
- Move vehicle ahead slowly and make a service brake application to check brake response.

Air Over Hydraulic (Air Actuated) Brake System

The pre-trip air brake inspection should be completed within 20 minutes. Failure to complete the test within 20 minutes may result in the test being discontinued.

Practical examination will be conducted in either the Metric or Imperial systems of measurement, whichever coincides with the equipment being operated.

Vehicle Secure

- Apply the parking brake on the vehicle.
- Block the wheels; the vehicle should be on level ground if possible.
- Check hydraulic fluid level in the reservoir.
- Check under the hood for hydraulic fluid leaks.
- Check that the compressor is secure.
- Check the drive belt and pulleys for wear, cracking, slippage

and tension (if equipped).

- Drain all air reservoirs completely (supply air reservoir first). When air reservoirs are empty close the drain valves. “For testing purposes only, the applicant will not be required to manually drain the reservoirs. Instead, the applicant may verbally explain the steps that they would follow when draining the reservoirs and then fan the brake pedal to empty the reservoir”.
- Check wheel cylinders and lines for signs of hydraulic fluid leaks.

Compressor and Warning Devices Check

- Start the engine and run at fast idle to build air pressure.
- Warning device(s) must operate to 55 psi or higher.
- Ensure reservoir pressure builds from 50 to 90 psi within three minutes.
- If equipped with spring parking brakes release them to prevent compounding the brake pressure.
- Continue building reservoir air pressure. Check that the governor places the compressor in the unloading stage between 115 psi minimum and 135 psi maximum.
- Fan the brake pedal until the pressure drops to 80 psi; stop fanning to see if the governor has placed the compressor in the loading stage (needle on the air gauge should start to climb).
- Continue fanning the brake pedal. Warning device(s) must operate at or before 55 psi.

Check for Leakage

- Rebuild reservoir air pressure to between 115 psi minimum

and 135 psi maximum (if equipped release the spring parking brakes).

- Shut off the engine.
- Make a full brake application with the foot valve and hold. Observe the reservoir air pressure gauge.
- The reading should not drop more than 4 psi per minute. Lightly tap the gauge to ensure it is not sticking. For an accurate reading application should be held for at least two minutes.
- Listen for audible air leaks.
- Release full brake application.

Brake Test

- Re-apply the parking brake, remove wheel blocks.
- Gently tug against the parking brakes in low gear, it should hold the vehicle.
- Release the parking brakes.
- Move vehicle ahead slowly and make a service brake application to check brake response.

Metric Conversion Table

As some trucks have air gauges indicating pressure in kilopascals (kPa), the following conversion chart may help.

psi to kPa

1	6.89
2	13.78
3	20.68
4	27.57
5	34.47
6	41.36
7	48.26
8	55.15
9	62.05
10	68.94
15	103.42
20	137.89
25	172.36
30	206.84
35	241.31
40	275.78
45	310.26
50	344.73

psi to kPa

55	379.20
60	413.68
65	448.15
70	482.62
75	517.10
80	551.57
85	586.04
90	620.52
95	654.99
100	689.47
105	723.94
110	758.41
115	792.89
120	827.36
125	861.83
130	896.31
135	930.78
140	965.25



Chapter 8

NWT Air Brake Manual

Electronic Controlled
Braking and
Traction System

Braking and Traction Systems

The following information is presented to make the driver aware of what is new in today's commercial vehicles. The explanations will be brief but once familiarized with the vehicle the driver will be able to identify if these systems are present.

Anti-lock Brake System (ABS)

An anti-lock brake system is an electronic system that monitors wheel speed at all times and controls wheel speed while braking. If it detects a wheel locking-up during a brake application, the system releases brake pressure to that wheel only. This keeps the wheel from skidding and increases vehicle stability and control during emergency stops and in adverse situations such as on wet or ice slicked roads, through curves or during lane changes. The air brake system remains the same with the addition of the ABS components.

An ABS basically consists of:

- An electronic control unit (ECU)
- A wheel sensor and tooth wheel
- ABS valves

Automatic Traction Control (ATC)

Automatic traction control is an electronic system that monitors wheel spin on acceleration and uses controlled braking to gain traction. This system reduces the potential of powering into a jackknife caused by wheel overspin during acceleration, along

with improving the ability of the driver to manoeuvre the vehicle on slippery surfaces through curves and lane changes. ATC is an option only available on vehicles equipped with ABS.

